



# POWERWARE® 5125

Two-in-One

User's Guide

2400–3000 VA

[www.powerware.com](http://www.powerware.com)

## **Requesting a Declaration of Conformity**

Units that are labeled with a CE mark comply with the following harmonized standards and EU directives:

- Harmonized Standards: EN 50091-1-1 and EN 50091-2; IEC 950 Second Edition, Amendments A1, A2, A3, and A4
- EU Directives: 73/23/EEC, Council Directive on equipment designed for use within certain voltage limits  
93/68/EEC, Amending Directive 73/23/EEC  
89/336/EEC, Council Directive relating to electromagnetic compatibility  
92/31/EEC, Amending Directive 89/336/EEC relating to EMC

The EC Declaration of Conformity is available upon request for products with a CE mark. For copies of the EC Declaration of Conformity, contact:

Powerware Corporation  
Koskelontie 13  
FIN-02920 Espoo  
Finland  
Phone: +358-9-452 661  
Fax: +358-9-452 665 68

Powerware is a registered trademark and Advanced Battery Management Plus (ABM Plus), X-Slot, and ConnectUPS are trademarks of Powerware Corporation.

© Copyright 2002 Powerware Corporation, Raleigh, NC, USA. All rights reserved. No part of this document may be reproduced in any way without the express written approval of Powerware Corporation.

## Class A EMC Statements

### FCC Part 15

**NOTE** This equipment has been tested and found to comply with the limits for a Class A digital device, pursuant to part 15 of the FCC Rules. These limits are designed to provide reasonable protection against harmful interference when the equipment is operated in a commercial environment. This equipment generates, uses, and can radiate radio frequency energy and, if not installed and used in accordance with the instruction manual, may cause harmful interference to radio communications. Operation of this equipment in a residential area is likely to cause harmful interference in which case the user will be required to correct the interference at his own expense.

### ICES-003

This Class A Interference Causing Equipment meets all requirements of the Canadian Interference Causing Equipment Regulations ICES-003.

Cet appareil numérique de la classe A respecte toutes les exigences du Règlement sur le matériel brouilleur du Canada.

### EN50091-2

Some configurations are classified under EN50091-2 as “Class-A UPS for Unrestricted Sales Distribution.” For these configurations, the following applies:

**WARNING** This is a Class A-UPS Product. In a domestic environment, this product may cause radio interference, in which case, the user may be required to take additional measures.

### VCCI Notice

この装置は、情報処理装置等電波障害自主規制協議会（VCCI）の基準に基づくクラスA情報技術装置です。この装置を家庭環境で使用すると電波妨害を引き起こすことがあります。この場合には使用者が適切な対策を講ずるよう要求されることがあります。

## Special Symbols

The following are examples of symbols used on the UPS to alert you to important information:



**RISK OF ELECTRIC SHOCK** - Indicates that a risk of electric shock is present and the associated warning should be observed.



**CAUTION: REFER TO OPERATOR'S MANUAL** - Refer to your operator's manual for additional information, such as important operating and maintenance instructions.



This symbol indicates that you should not discard the UPS or the UPS batteries in the trash. The UPS may contain sealed, lead-acid batteries. Batteries must be recycled.



# TABLE OF CONTENTS

<b>1 Powerware 5125</b> .....	<b>1</b>
<b>2 Safety Warnings</b> .....	<b>3</b>
<b>3 Installation</b> .....	<b>17</b>
Inspecting the Equipment .....	17
UPS Setup .....	17
Rack-Mount Setup .....	18
Cabinet Setup .....	19
Installing the UPS .....	24
UPS Rear Panels .....	26
<b>4 Operation</b> .....	<b>29</b>
Turning the UPS On .....	29
Starting the UPS on Battery .....	29
Turning the UPS Off .....	29
Initiating the Self-Test .....	30
Operating Modes .....	30
Normal Mode .....	31
Battery Mode .....	31
Bypass Mode .....	32
Standby Mode .....	32
<b>5 Additional UPS Features</b> .....	<b>33</b>
X-Slot Modules .....	33
Single-Port Module .....	34
Load Segments .....	36
Remote Emergency Power-Off .....	37
<b>6 UPS Maintenance</b> .....	<b>39</b>
UPS and Battery Care .....	39
Storing the UPS and Batteries .....	39
Replacing the Electronics Module .....	40
When to Replace Batteries .....	41

Replacing Batteries .....	41
How to Replace Extended Battery Modules .....	42
How to Replace Internal Batteries .....	43
Testing New Batteries .....	44
Recycling the Used Battery .....	45
<b>7 Specifications .....</b>	<b>47</b>
<b>8 Troubleshooting .....</b>	<b>51</b>
Audible Alarms and UPS Conditions .....	51
Silencing an Audible Alarm .....	51
Service and Support .....	54



## CHAPTER 1

# POWERWARE 5125

The Powerware® 5125 uninterruptible power system (UPS) protects your sensitive electronic equipment from basic power problems such as power failures, power sags, power surges, brownouts, and line noise.

Power outages can occur when you least expect it and power quality can be erratic. These power problems have the potential to corrupt critical data, destroy unsaved work sessions, and damage hardware — causing hours of lost productivity and expensive repairs.

With the Powerware 5125, you can safely eliminate the effects of power disturbances and guard the integrity of your equipment. The Powerware 5125 is designed for critical applications such as PCs, servers, workstations, and telecommunications equipment. Figure 1 shows the Powerware 5125 UPS with an optional Extended Battery Module (EBM).

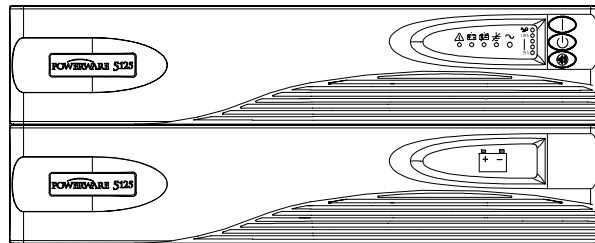

**Figure 1. The Powerware 5125**

Providing outstanding performance and reliability, the Powerware 5125's unique benefits include the following:

- 2U rack height conserves valuable rack space.
- Advanced Battery Management Plus (ABM Plus™) doubles battery service life, optimizes recharge time, and provides a warning before the end of useful battery life.
- Hours of extended run time with up to four EBMs.
- Hot-swappable batteries simplify maintenance by allowing you to replace batteries safely without powering down the critical load.

- Start-on-battery capability allows you to power up the UPS even if utility power is not available.
- Advanced power management with the Software Suite CD for graceful shutdowns and power monitoring.
- Sequential shutdown and load management through separate receptacle groups, called load segments.
- Emergency shutdown control through the Remote Emergency Power-Off (REPO) port.
- Optional X-Slot™ modules provide enhanced communication capabilities for increased power protection and control.
- The Powerware 5125 is backed by worldwide agency approvals.



## CHAPTER 2

# SAFETY WARNINGS

Read the following precautions before you install the UPS.

### IMPORTANT SAFETY INSTRUCTIONS

SAVE THESE INSTRUCTIONS. This manual contains important instructions that you should follow during installation and maintenance of the UPS and batteries. Please read all instructions before operating the equipment and save this manual for future reference.

---

### DANGER



This UPS contains **LETHAL VOLTAGES**. All repairs and service should be performed by **AUTHORIZED SERVICE PERSONNEL ONLY**. There are **NO USER SERVICEABLE PARTS** inside the UPS.

---

### WARNING



- This UPS contains its own energy source (batteries). The output receptacles may carry live voltage even when the UPS is not connected to an AC supply.
  - Do not remove or unplug the input cord when the UPS is turned on. This removes the safety ground from the UPS and the equipment connected to the UPS.
  - To reduce the risk of fire or electric shock, install this UPS in a temperature and humidity controlled, indoor environment, free of conductive contaminants. Ambient temperature must not exceed 40°C (104°F). Do not operate near water or excessive humidity (95% max).
  - To comply with international standards and wiring regulations, the total equipment connected to the output of this UPS must not have an earth leakage current greater than 2.5 milliamperes.
-



### CAUTION

- Batteries can present a risk of electrical shock or burn from high short-circuit current. Observe proper precautions. Servicing should be performed by qualified service personnel knowledgeable of batteries and required precautions. Keep unauthorized personnel away from batteries.
- Proper disposal of batteries is required. Refer to your local codes for disposal requirements.
- Never dispose of batteries in a fire. Batteries may explode when exposed to flame.

## Sikkerhedsanvisninger

### VIGTIGE SIKKERHEDSANVISNINGER GEM DISSE ANVISNINGER DENNE BRUGERVEJLEDNING INDEHOLDER VIGTIGE SIKKERHEDSANVISNINGER



### FARE

Denne UPS indeholder LIVSFARLIG HØJSPÆNDING. Alle reparationer og vedligeholdelse bør kun udføres af en AUTORISERET SERVICETEKNIKER. Ingen af UPS'ens indvendige dele kan repareres af brugeren.



### ADVARSEL!

- Denne UPS indeholder egen energiforsyning (batterier). Udgangsnetstikkene kan lede strøm, selv når UPS'en ikke er tilsat en AC-energikilde.
- Netledningen må ikke fjernes og stikket må ikke trækkes ud, mens UPS'en er tændt. Dette fjerner sikkerhedsjorden fra UPS'en og fra det udstyr, der er sat til.
- Installér denne UPS i et temperatur- og fugtighedskontrolleret indendørsmiljø, frit for ledende forureningsstoffer for at formindske risikoen for brand og elektrisk stød. Rumtemperaturen må ikke overstige 40°C. UPS'en bør ikke betjenes nær vand eller høj fugtighed (maksimalt 95%).
- I overensstemmelse med internationale normer og bestemmelser for el-installation må det udstyr, der er forbundet til udgangen af denne UPS, tilsammen ikke overskride en jordafdelingsspænding på mere end 2,5 milliamperere.



### ADVARSEL

- Batterier kan udgøre en fare for elektrisk stød eller forbrændinger forårsaget af høj kortslutningsspænding. De korrekte forholdsregler bør overholdes.
- Korrekt bortskaffelse af batterier er påkrævet. Overhold gældende lokale regler for bortskaffelsesprocedurer.
- Skaf dig aldrig af med batterierne ved at brænde dem. Batterierne kan eksplodere ved åben ild.

## Belangrijke Veiligheidsinstructies

### BELANGRIJKE VEILIGHEIDSINSTRUCTIES BEWAAR DEZE INSTRUCTIES DEZE HANDLEIDING BEVAT BELANGRIJKE VEILIGHEIDSINSTRUCTIES



### GEVAAR

Deze UPS bevat LEVENSGEVAARLIJKE ELEKTRISCHE SPANNING. Alle reparaties en onderhoud dienen UITSLUITEND DOOR ERKEND SERVICEPERSONEEL te worden uitgevoerd. Er bevinden zich GEEN ONDERDELEN in de UPS die DOOR DE GEBRUIKER kunnen worden GEREPAREERD.



### WAARSCHUWING

- Deze UPS bevat zijn eigen energiebron (batterijen). De uitgangsaansluitingen kunnen onder spanning staan wanneer de UPS niet op een wisselstroom voeding is aangesloten.
- Verwijder de ingang snoer niet of haal de stekker van de ingang snoer er niet uit terwijl de UPS aan staat. Hierdoor zou de UPS en uw aangesloten apparatuur geen aardebeveiliging meer hebben.
- Teneinde de kans op brand of elektrische schok te verminderen dient deze UPS in een gebouw met temperatuur- en vochtigheidsregeling te worden geïnstalleerd, waar geen geleidende verontreinigingen aanwezig zijn. De omgevingstemperatuur mag 40°C niet overschrijden. Niet gebruiken in de buurt van water of bij zeer hoge vochtigheid (max. 95%).
- Om aan de internationale normen en bedradingsvoorschriften te voldoen mag de gehele apparatuur die op de uitgang van deze UPS is aangesloten, geen aardlekstroom van meer dan 2,5 milliampère hebben.



## OPGELET

- Batterijen kunnen gevaar voor elektrische schok of brandwonden veroorzaken als gevolg van een hoge kortsluitstroom. Volg de desbetreffende aanwijzingen op.
- De batterijen moeten op de juiste wijze worden opgeruimd. Raadpleeg hiervoor uw plaatselijke voorschriften.
- Nooit batterijen in het vuur gooien. De batterijen kunnen ontploffen.

## Tarkeita Turvaohjeita

### TÄRKEITÄ TURVAOHJEITA - SUOMI SÄILYÄ NÄMÄ OHJEET TÄMÄ OPAS SISÄLTÄÄ TÄRKEITÄ TURVAOHJEITA



## VAARA

Tämä UPS sisältää HENGENVAARALLISIA JÄNNITTEITÄ. Kaikki korjaukset ja huollot on jätettävä VAIN VALTUUTETUN HUOLTOHENKILÖN TOIMEKSI. UPS ei sisällä MITÄÄN KÄYTTÄJÄN HUOLLETTAVIA OSIA.



## VAROITUS

- Tämä UPS sisältää oman energialähteen (akuston). Ulostuloliittimissä voi olla jännite, kun UPS ei ole liitettyä verkkojännitteeseen.
- Älä poista tai irrota sisääntulojohtoa, kun UPS on kytkettynä. Tämä poistaa turvamaadoituksen UPS-laitteesta ja siihen liitetystä laitteistosta.
- Vähentääksesi tulipalon ja sähköiskun vaaraa asenna tämä UPS sisätiloihin, joissa lämpötila ja kosteus on säädettävissä ja joissa ei ole virtaa johtavia epäpuhtauksia. Ympäristön lämpötila ei saa ylittää 40 °C. Älä käytä lähellä vettä ja vältä kosteita tiloja (95 % maksimi).
- Kansainväliset normit ja johdotusmääräykset vaativat, että kaikkien tämän UPS-laitteen ulostulokytkentöjen yhteinen maavuotovirta ei ylitä 2,5 milliampeeria (mA).



## VARO

- Akusto saattaa aiheuttaa sähköiskun tai syttyä tuleen, jos akusto kytketään oikosulkuun. Noudata asianmukaisia ohjeita.
- Akusto täytyy hävittää säädösten mukaisella tavalla. Noudata paikallisia määräyksiä.
- Älä koskaan heitä akkuja tuleen. Ne voivat räjähtää.

## Consignes de sécurité

### CONSIGNES DE SÉCURITÉ IMPORTANTES CONSERVER CES INSTRUCTIONS CE MANUEL CONTIENT DES CONSIGNES DE SÉCURITÉ IMPORTANTES



## DANGER!

Cet onduleur contient des TENSIONS MORTELLES. Toute opération d'entretien et de réparation doit être EXCLUSIVEMENT CONFIEE A UN PERSONNEL QUALIFIE AGRÉÉ. AUCUNE PIÈCE RÉPARABLE PAR L'UTILISATEUR ne se trouve dans l'onduleur.



## AVERTISSEMENT!

- Cet onduleur renferme sa propre source d'énergie (batteries). Les prises de sortie peuvent être sous tension même lorsque l'onduleur n'est pas branché sur le secteur.
- Ne pas retirer le cordon d'alimentation lorsque l'onduleur est sous tension sous peine de supprimer la mise à la terre de l'onduleur et du matériel connecté.
- Pour réduire les risques d'incendie et de décharge électrique, installer l'onduleur uniquement à l'intérieur, dans un lieu dépourvu de matériaux conducteurs, où la température et l'humidité ambiantes sont contrôlées. La température ambiante ne doit pas dépasser 40 °C. Ne pas utiliser à proximité d'eau ou dans une atmosphère excessivement humide (95 % maximum).
- Afin d'être conforme aux normes et règlements internationaux de câblage, le courant de fuite à la terre de la totalité du matériel branché sur la sortie de l'onduleur ne doit pas dépasser 2,5 mA.



### ATTENTION!

- Les batteries peuvent présenter un risque de décharge électrique ou de brûlure par des courts-circuits de haute intensité. Prendre les précautions nécessaires.
  - Une mise au rebut réglementaire des batteries est obligatoire. Consulter les règlements en vigueur dans votre localité.
  - Ne jamais jeter les batteries au feu. L'exposition aux flammes risque de les faire exploser.
- 

## Sicherheitswarnungen

### WICHTIGE SICHERHEITSANWEISUNGEN AUFBEWAHREN. DIESES HANDBUCH ENTHÄLT WICHTIGE SICHERHEITSANWEISUNGEN.



### WARNUNG

Die USV führt lebensgefährliche Spannungen. Alle Reparatur- und Wartungsarbeiten sollten nur von Kundendienstfachleuten durchgeführt werden. Die USV enthält keine vom Benutzer zu wartenden Komponente

---



### ACHTUNG

- Diese USV ist mit einer eigenen Energiequelle (Batterie) ausgestattet. An den Ausgangssteckdosen kann auch dann Spannung anliegen, wenn die USV nicht an einer Wechselspannungsquelle angeschlossen ist.
  - Das Eingangskabel nicht entfernen oder abziehen, während die USV eingeschaltet ist, weil hierdurch die Sicherheitserdung von der USV und den daran angeschlossenen Geräten entfernt wird.
  - Um die Brand- oder Elektroschockgefahr zu verringern, diese USV nur in Gebäuden mit kontrollierter Temperatur und Luftfeuchtigkeit installieren, in denen keine leitenden Schmutzstoffen vorhanden sind. Die Umgebungstemperatur darf 40°C nicht übersteigen. Die USV nicht in der Nähe von Wasser oder in extrem hoher Luftfeuchtigkeit (max. 95 %) betreiben.
  - Um internationale Normen und Verdrahtungsvorschriften zu erfüllen, dürfen die an den Ausgang dieser USV angeschlossenen Geräte zusammen einen Erdschlußstrom von insgesamt 2,5 Milliampere nicht überschreiten.
-



### VORSICHT!

- Batterien können aufgrund des hohen Kurzschlußstroms Elektroschocks oder Verbrennungen verursachen. Die entsprechenden Vorsichtsmaßnahmen sind unbedingt zu beachten.
- Die Batterien müssen ordnungsgemäß entsorgt werden. Hierbei sind die örtlichen Bestimmungen zu beachten.
- Batterien niemals verbrennen, da sie explodieren können.

## Προειδοποιήσεις Ασφάλειας

### ΣΗΜΑΝΤΙΚΕΣ ΟΔΗΓΙΕΣ ΑΣΦΑΛΕΙΑΣ ΦΥΛΑΞΤΕ ΑΥΤΕΣ ΤΙΣ ΟΔΗΓΙΕΣ ΤΟ ΠΑΡΟΝ ΕΓΧΕΙΡΙΔΙΟ ΠΕΡΙΕΧΕΙ ΣΗΜΑΝΤΙΚΕΣ ΟΔΗΓΙΕΣ ΑΣΦΑΛΕΙΑΣ



### ΚΙΝΔΥΝΟΣ

Αυτό το UPS περιέχει ΘΑΝΑΤΗΦΟΡΑ ΤΑΣΗ. Όλες οι επισκευές και οι συντηρήσεις πρέπει να γίνονται ΜΟΝΟ ΑΠΟ ΕΞΟΥΣΙΟΔΟΤΗΜΕΝΟ ΓΙΑ ΤΗ ΣΥΝΤΗΡΗΣΗ ΠΡΟΣΩΠΙΚΟ. Το UPS ΔΕΝ ΠΕΡΙΕΧΕΙ ΚΑΝΕΝΑ ΕΞΑΡΤΗΜΑ ΠΟΥ ΝΑ ΜΠΟΡΕΙ ΝΑ ΕΠΙΣΚΕΥΑΣΤΕΙ ΑΠΟ ΤΟ ΧΡΗΣΤΗ.



### ΠΡΟΕΙΔΟΠΟΙΗΣΗΚ

- Το συγκεκριμένο UPS περιέχει τη δική του πηγή ενέργειας (συσσωρευτές). Οι ρευματοδότες εξόδου μπορεί να έχουν ενεργό τάση ακόμη και όταν το UPS δεν είναι συνδεδεμένο σε πηγή εναλλασσόμενου ρεύματος (AC).
- Μην βγάζετε από την πρίζα το καλώδιο τροφοδοσίας όταν το UPS είναι ανοιχτό. Μ' αυτό τον τρόπο αφαιρείτε τη γείωση ασφαλείας από το UPS και από τον εξοπλισμό που είναι συνδεδεμένος με το UPS.
- Για να μειώσετε τον κίνδυνο πυρκαγιάς ή ηλεκτροπληξίας, εγκαταστήστε το συγκεκριμένο UPS σε εσωτερικό χώρο με ελεγχόμενη θερμοκρασία και υγρασία, ο οποίος να μην περιέχει αγωγικά υλικά. Η θερμοκρασία περιβάλλοντος δεν πρέπει να ξεπερνάει τους 40° C. Μην χρησιμοποιείτε το UPS κοντά σε νερό ή υπερβολική υγρασία (μέγιστη τιμή: 95%).

- Για να συμφωνεί με τα διεθνή πρότυπα και τους κανονισμούς καλωδίωσης, το ρεύμα διαρροής προς τη γη ολόκληρου του εξοπλισμού, που είναι συνδεδεμένος με την έξοδο του συγκεκριμένου UPS, δεν πρέπει να είναι μεγαλύτερο από 2,5 mA.

### ΠΡΟΣΟΧΗ



- Οι συσσωρευτές μπορεί να προκαλέσουν ηλεκτροπληξία ή έγκαυμα από υψηλό ρεύμα βραχυκυκλώματος. Λαμβάνετε τις κατάλληλες προφυλάξεις.
- Απαιτείται σωστή διάθεση των συσσωρευτών. Δείτε τους τοπικούς κανονισμούς που αφορούν τις απαιτήσεις διάθεσής τους.
- Ποτέ μην πετάτε τους συσσωρευτές στη φωτιά, γιατί μπορεί να εκραγούν.

## Avvisi di sicurezza

### IMPORTANTI ISTRUZIONI DI SICUREZZA CONSERVARE QUESTE ISTRUZIONI QUESTO MANUALE CONTIENE IMPORTANTI ISTRUZIONI DI SICUREZZA

#### PERICOLO



la TENSIONE contenuta in questo gruppo statico di continuità è LETALE. Tutte le operazioni di riparazione e di manutenzione devono essere effettuate ESCLUSIVAMENTE DA PERSONALE TECNICO AUTORIZZATO. All'interno del gruppo statico di continuità NON vi sono PARTI RIPARABILI DALL'UTENTE.

#### AVVERTENZA



- Questo gruppo statico di continuità contiene una fonte di energia autonoma (le batterie). Le prese di uscita possono condurre tensione energizzata quando il gruppo statico di continuità non è collegato con una fonte di alimentazione a corrente alternata.
- Non rimuovere nè scollegare il cavo di ingresso quando il gruppo statico di continuità è acceso poichè in tal modo si disattiverrebbe il collegamento a terra di sicurezza del gruppo statico di continuità e dell'apparecchiatura ad esso collegata.

- Per ridurre il rischio di incendio o di scossa elettrica, installare il gruppo statico di continuità in un ambiente interno a temperatura ed umidità controllata, privo di agenti contaminanti conduttivi. La temperatura ambiente non deve superare i 40°C. Non utilizzare l'unità in prossimità di acqua o in presenza di umidità eccessiva (95% max).
- Per conformità con gli standard internazionali e con le norme in merito al cablaggio, tutta l'apparecchiatura collegata con l'uscita del gruppo statico di continuità non deve avere una corrente di dispersione di terra superiore a 2,5 milliampere.

### ATTENZIONE



- Le batterie possono presentare rischio di scossa elettrica o di ustioni provocate da alta corrente dovuta a corto circuito. Osservare le apposite istruzioni.
- Le batterie devono essere smaltite in modo corretto. Per i requisiti di smaltimento fare riferimento alle disposizioni locali.
- Non gettare mai le batterie nel fuoco poichè potrebbero esplodere se esposte alle fiamme.

## Viktig Sikkerhetsinformasjon

### FARLIG



Denne UPS'en inneholder LIVSFARLIGE SPENNINGER. All reparasjon og service må kun utføres av AUTORISERT SERVICEPERSONALE. BRUKERE KAN IKKE UTFØRE SERVICE PÅ NOEN AV DELENE i UPS'en.

### FARLIG



- Denne UPS'en har en egen energikilde (batterier). Stikkontaktene kan være strømførende selv om UPS'en ikke er tilsluttet en vekselstrømforsyning.
- Strømforsyningskabelen må ikke fjernes eller trekkes ut når UPS'en er på, slik at ikke sikkerhetsjordingen fjernes fra UPS'en og det utstyret som er forbundet med den.
- For å redusere fare for brann eller elektriske støt, bør denne UPS'en installeres i et innendørs miljø med kontrollert temperatur og luftfuktighet som er fritt for ledende, forurensende stoffer. Romtemperaturen må ikke overskride 40°C. Den må ikke brukes i nærheten av vann eller ved meget høy luftfuktighet (95% maks.).

- Alt utstyr som er forbundet med utgangen av denne UPS'en må ikke ha en sterkere total lekkasjestrøm enn 2,5 milliampere for å være i overensstemmelse med internasjonale standarder og forkablingsbestemmelser.

### **FORSIKTIG**



- Batterier kan forårsake elektriske støt eller forbrenning på grunn av høy kortslutningsstrøm. Følg instruksene.
- Batterier må fjernes på korrekt måte. Se lokale forskrifter vedrørende krav om fjerning av batterier.
- Kast aldri batterier i flammer, da de kan eksplodere, hvis de utsettes for åpen ild.

## **Regulamentos de Segurança**

### **INSTRUÇÕES DE SEGURANÇA IMPORTANTES GUARDE ESTAS INSTRUÇÕES ESTE MANUAL CONTÉM INSTRUÇÕES DE SEGURANÇA IMPORTANTES**

#### **CUIDADO**



A UPS contém VOLTAGEM MORTAL. Todos os reparos e assistência técnica devem ser executados SOMENTE POR PESSOAL DA ASSISTÊNCIA TÉCNICA AUTORIZADO. Não há nenhuma PEÇA QUE POSSA SER REPARADA PELO USUÁRIO dentro da UPS.

#### **ADVERTÊNCIA**



- Esta UPS contém sua própria fonte de energia (baterias). Os receptáculos de saída podem conter voltagem ativa quando a UPS não se encontra conectada a uma fonte de alimentação de corrente alternada.
- Não remova ou desconecte o cabo de entrada quando a UPS estiver ligada. Isto removerá o aterramento de segurança da UPS e do equipamento conectado.
- Para reduzir o risco de incêndios ou choques elétricos, instale a UPS em ambiente interno com temperatura e umidade controladas e livres de contaminadores condutíveis. A temperatura ambiente não deve exceder 40°C. Não opere próximo a água ou em umidade excessiva (máx: 95%).
- Para estar de acordo com os padrões internacionais e os regulamentos de fiação, o equipamento total conectado à saída desta UPS não deve ter uma corrente de fuga à terra maior que 2,5 miliampères.



## PERIGO

- As baterias podem apresentar o risco de choque elétrico, ou queimaduras provenientes de alta corrente de curto-circuito. Observe as instruções adequadas.
- Siga as instruções apropriadas ao desfazer-se das baterias. Consulte os códigos do local para maiores informações sobre os regulamentos de descarte de produtos.
- Nunca jogue as baterias no fogo, porque há risco de explosão.

## Предупреждения по мерам безопасности

### ВАЖНЫЕ УКАЗАНИЯ ПО МЕРАМ БЕЗОПАСНОСТИ СОХРАНИТЕ ЭТИ УКАЗАНИЯ ДАННОЕ РУКОВОДСТВО СОДЕРЖИТ ВАЖНЫЕ УКАЗАНИЯ ПО МЕРАМ БЕЗОПАСНОСТИ



## ОПАСНО

В данном ИБП имеются СМЕРТЕЛЬНО ОПАСНЫЕ НАПРЯЖЕНИЯ. Все работы по ремонту и обслуживанию должны выполняться ТОЛЬКО УПОЛНОМОЧЕННЫМ ОБСЛУЖИВАЮЩИМ ПЕРСОНАЛОМ. Внутри ИБП нет узлов, ОБСЛУЖИВАЕМЫХ ПОЛЬЗОВАТЕЛЕМ.



## ПРЕДУПРЕЖДЕНИЕ

- Данный ИБП содержит собственные источники энергии (аккумуляторы). На выходных розетках может иметься напряжение, даже когда ИБП не подключен к сети переменного тока.
- Не отсоединяйте сетевой шнур и не извлекайте его вилку из розетки при включенном ИБП. При этом защитное заземление отключается от ИБП и от оборудования, подключенного к ИБП.
- Для снижения опасности пожара или поражения электрическим током устанавливайте ИБП в закрытом помещении с контролируемой температурой и влажностью, в котором отсутствуют проводящие загрязняющие вещества. Температура окружающего воздуха не должна превышать 40°C. Не эксплуатируйте устройство около воды или в местах с повышенной влажностью (макс. 95%).

- Для обеспечения соблюдения требований международных стандартов и требований к разводке электрических цепей, суммарная величина тока утечки на землю всего оборудования, подключенного к выходу ИБП, не должна превышать 2,5 миллиампера.



### ОСТОРОЖНО

- Аккумуляторы могут вызвать опасность поражения электрическим током или ожога от тока короткого замыкания. Соблюдайте соответствующие меры предосторожности.
- Необходимо соблюдать правила утилизации аккумуляторов. Обратитесь к местным нормативным актам за информацией о требованиях к утилизации.
- Никогда не бросайте аккумуляторы в огонь. Аккумуляторы могут взорваться под воздействием огня.

## Advertencias de Seguridad

### INSTRUCCIONES DE SEGURIDAD IMPORTANTES GUARDE ESTAS INSTRUCCIONES ESTE MANUAL CONTIENE INSTRUCCIONES DE SEGURIDAD IMPORTANTES



### PELIGRO

Este SIE contiene VOLTAJES MORTALES. Todas las reparaciones y el servicio técnico deben ser efectuados SOLAMENTE POR PERSONAL DE SERVICIO TÉCNICO AUTORIZADO. No hay NINGUNA PARTE QUE EL USUARIO PUEDA REPARAR dentro del SIE.



### ADVERTENCIA

- Este SIE contiene su propia fuente de energía (las baterías). Los receptáculos de salida pueden transmitir corriente eléctrica aun cuando el SIE no esté conectado a un suministro de corriente alterna (c.a.).
- No retire o desenchufe el cable de entrada mientras el SIE se encuentre encendido. Esto suprime la descarga a tierra de seguridad del SIE y de los equipos conectados al SIE.

- Para reducir el riesgo de incendio o de choque eléctrico, instale este SIE en un lugar cubierto, con temperatura y humedad controladas, libre de contaminantes conductores. La temperatura ambiente no debe exceder los 40°C. No trabaje cerca del agua o con humedad excesiva (95% máximo).
- Para cumplir con los estándares internacionales y las normas de instalación, la totalidad de los equipos conectados a la salida de este SIE no debe tener una intensidad de pérdida a tierra superior a los 2,5 miliamperios.

### PRECAUCIÓN



- Las baterías pueden presentar un riesgo de descargas eléctricas o de quemaduras debido a la alta corriente de cortocircuito. Preste atención a las instrucciones correspondientes.
- Es necesario desechar las baterías de un modo adecuado. Consulte las normas locales para conocer los requisitos pertinentes.
- Nunca deseche las baterías en el fuego. Las baterías pueden explotar si se las expone a la llama.

## Säkerhetsföreskrifter

### VIKTIGA SÄKERHETSFÖRESKRIFTER SPARA DESSA FÖRESKRIFTER DENNA BRUKSANVISNING INNEHÅLLER VIKTIGA SÄKERHETSFÖRESKRIFTER

#### FARA



Denna UPS-enhet innehåller LIVSFARLIG SPÄNNING. ENDAST AUKTORISERAD SERVICEPERSONAL får utföra reparationer eller service. Det finns inga delar som ANVÄNDAREN KAN UTFÖRA SERVICE PÅ inuti UPS-enheten.

#### VARNING



- Denna UPS-enhet har en egen energikälla (batterier). De utgående kontakterna kan vara strömförande när UPS-enheten inte är ansluten till en växelströmkälla.
- Ta aldrig bort nätsladden när UPS-enheten är påslagen. Detta tar bort skyddsjordningen från både UPS-enheten och den anslutna utrustningen.

- Minska risken för brand eller elektriska stötar genom att installera denna UPS-enhet inomhus, där temperatur och luftfuktighet är kontrollerade och där inga ledande föroreningar förekommer. Omgivande temperatur får ej överstiga 40°C. Använd inte utrustningen nära vatten eller vid hög luftfuktighet (max 95 %).
  - För att överensstämna med internationell standard och installationsföreskrifter får inte den totala utrustning som anslutits till uttagen på denna UPS-enhet ha läcksström som överstiger 2,5 milliampere.
- 



### **VIKTIGT**

- Batterierna kan ge elektriska stötar eller brännskador från hög kortslutningsström. Följ tillämpliga anvisningar.
  - Batterierna måste avyttras enligt anvisningarna i lokal lagstiftning.
  - Använda batterier får aldrig brännas upp. De kan explodera.
-



## CHAPTER 3

# INSTALLATION

This section explains:

- Equipment inspection
- UPS setup and installation
- UPS rear panels

### Inspecting the Equipment

If any equipment has been damaged during shipment, keep the shipping cartons and packing materials for the carrier or place of purchase and file a claim for shipping damage. If you discover damage after acceptance, file a claim for concealed damage.

To file a claim for shipping damage or concealed damage: 1) File with the carrier within 15 days of receipt of the equipment; 2) Send a copy of the damage claim within 15 days to your service representative.

### UPS Setup

The Powerware 5125 UPS is designed for flexible configurations and can be installed in a rack or as a standalone cabinet.

If you are installing the UPS in a rack, continue to the following section, “Rack-Mount Setup;” otherwise, continue to “Cabinet Setup” on page 19.

## Rack-Mount Setup

The UPS can be installed in 19-inch racks and needs only 2U of valuable rack space.



### CAUTION

The UPS and Extended Battery Module are heavy (see page 47). A minimum of two people are required to lift the UPS into the rack.



**NOTE** Fixed mounting rails are required for each cabinet. If fixed rails are not already installed in your rack, contact your local distributor to order a rail kit.

Use the following procedure to install the UPS in a rack:

1. Place the UPS on a flat, stable surface with the front of the UPS facing toward you.
2. Attach the supplied mounting handles to the mounting brackets (see Figure 2).
3. If installing optional EBMs, repeat Steps 1 and 2 for each cabinet.

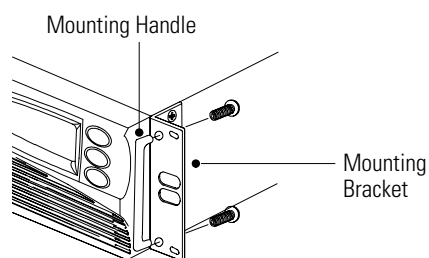

**Figure 2. Installing the Mounting Handles**



**NOTE** The UPS and EBMs MUST be installed at the bottom of the rack. If placed in a rack with existing equipment, the rack must be reconfigured to allow the UPS installation at the bottom of the rack.

**NOTE** The EBMs must be installed below the UPS as shown in Figure 3.

- Slide the UPS and any optional EBMs into the rack. Continue to “Installing the UPS” on page 24 to complete the installation.

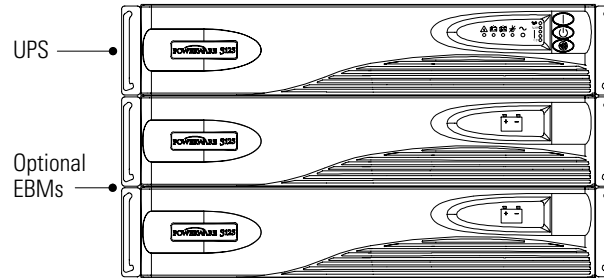

**Figure 3. Rack-Mount UPS with EBMs**

### Cabinet Setup

The rack-mounting brackets must be removed before positioning the cabinets for the cabinet setup. Unscrew and remove the mounting brackets on each side of all cabinets as shown in Figure 4.

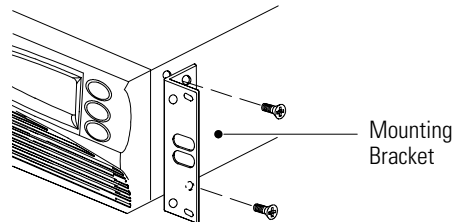

**Figure 4. Removing the Mounting Brackets**

You can position the UPS cabinets horizontally or vertically. When positioning the cabinets horizontally, the EBMs must be placed below the UPS (see Figure 5).

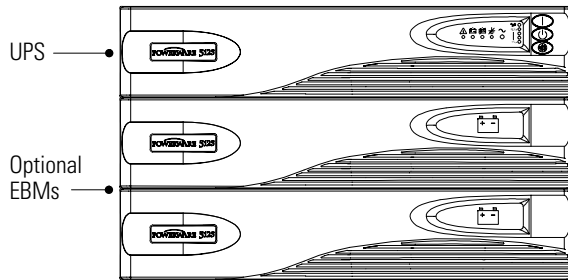

**Figure 5. Horizontal Cabinet Setup**

When positioning the cabinets vertically, the UPS and any optional EBMs must be stabilized with pedestals and/or EBM brackets. The vertical setup varies depending on the number of cabinets:

1. **For one cabinet**, both sets of pedestals must be installed. Complete Steps 2 through 4.
  - For two cabinets**, the pedestals and the EBM brackets must be installed. Skip to Step 5.
  - For three or more cabinets**, skip to Step 8 to install the EBM brackets.
2. Place the UPS cabinet horizontally so that the left end of the unit is accessible (see Figure 6).
3. Position the pedestals over the end of the UPS cabinet so that the weight of the unit is evenly distributed. Secure the pedestals with the screws provided in the accessory kit.

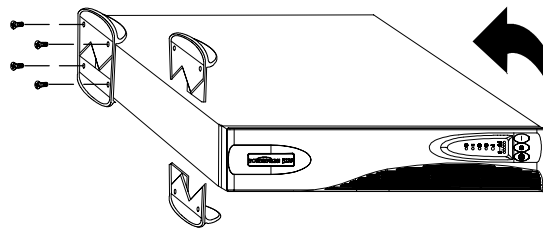

**Figure 6. Installing Pedestals on a Single Cabinet**

4. Carefully position the cabinet upright with the air vents at the top (see Figure 7).

Continue to “Installing the UPS” on page 24.

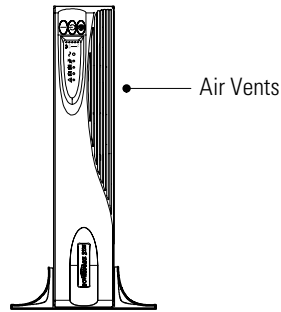

**Figure 7. Pedestals with One Cabinet**

5. Place the UPS cabinet horizontally so that the left end of the unit is accessible (see Figure 8).

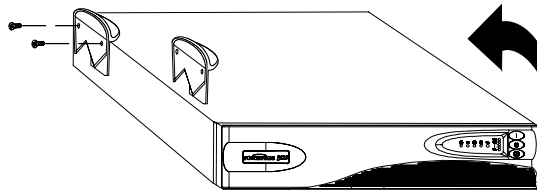

**Figure 8. Installing UPS Pedestals with Two Cabinets**

6. Place the EBM cabinet upside down so that the right end of the unit is accessible (see Figure 9).

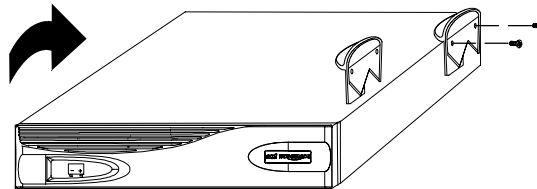

**Figure 9. Installing EBM Pedestals**

7. Position two of the pedestals over the edge of each cabinet so that the weight of the unit is evenly distributed. Secure the pedestals with the screws provided in the accessory kit.

- Carefully position the cabinets upright with the air vents at the top (see Figure 10 or Figure 11).

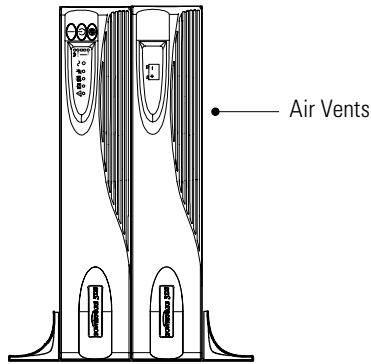

**Figure 10. Pedestals with Two Cabinets**



**NOTE** Pedestals are required for one and two cabinet installations. EBM brackets are required for all vertical EBM installations.

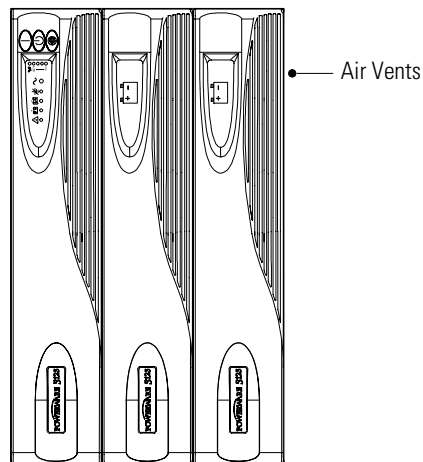

**Figure 11. Vertical Cabinet Setup**

- Align each EBM bracket with the adjacent corner screw holes and secure with the supplied screws.

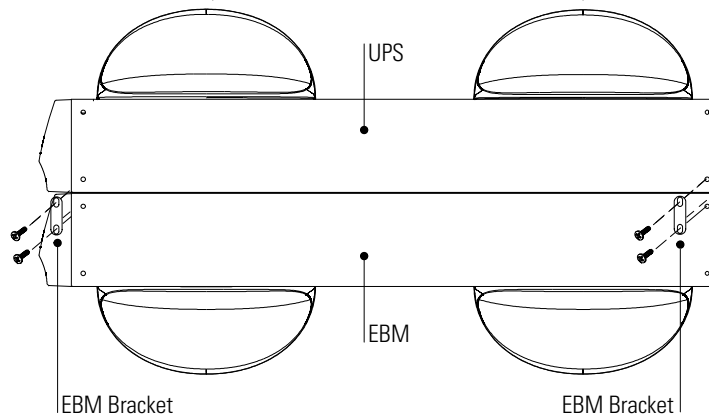

**Figure 12. Installing the EBM Brackets (Top View with Pedestals)**

- If installing additional EBMs, repeat Step 9 for each cabinet. Continue to the following section, “Installing the UPS.”

## Installing the UPS

The following steps explain how to install the UPS. Figure 13 shows a typical installation only. See “UPS Rear Panels” on page 26 for the rear panel of each model.



**NOTE** Do not make unauthorized changes to the UPS; otherwise, damage may occur to your equipment and void your warranty.

1. If installing an optional EBM, continue to Step 2; otherwise, skip to Step 5.
2. Plug the EBM cable into the UPS battery connector (see Figure 13).
3. Plug the other end of the EBM cable into the EBM battery connector.
4. For additional EBMs, plug the EBM cable into the battery connector of each EBM. Up to four EBMs may be connected to the UPS.

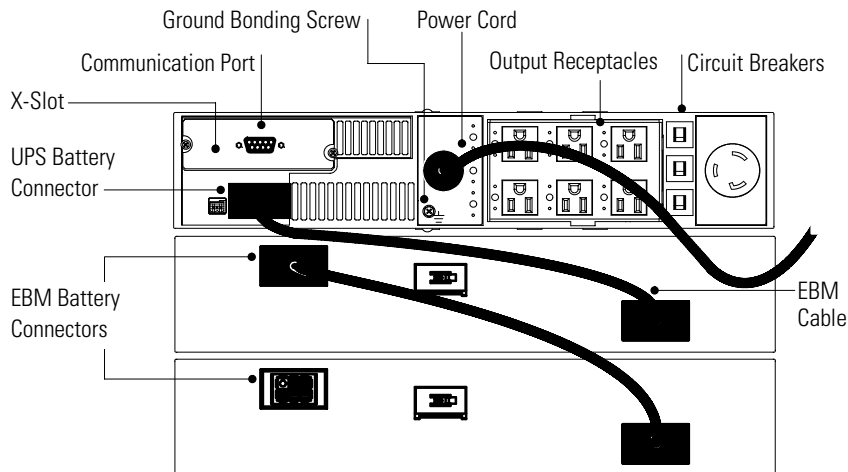

**Figure 13. Typical Installation with Two EBMs**

5. If you are installing power management software, connect your computer to the UPS communication port using the supplied communication cable.
6. **For Rack-Mount Installations only.** If your rack has conductors for grounding or bonding of ungrounded metal parts, connect the ground cable (not included) to the ground bonding screw.
7. Plug the equipment to be protected into the appropriate UPS output receptacles (see page 36 for more information on load segments).

DO NOT protect laser printers with the UPS because of the exceptionally high power requirements of the heating elements.

8. **For the PW5125 3000e and 3000g RM models only.** Plug the detachable UPS power cord into the input connector on the UPS rear panel.

Install a 16A plug on the other end of the cord that meets your local electrical code requirements for the AC power source.

9. Plug the UPS power cord into a power outlet. All front panel indicators flash briefly and the UPS conducts a self-test.

When the self-test is complete, the  $\sim$  indicator flashes, indicating the UPS is in Standby mode with the equipment offline. If the alarm beeps or a UPS alarm indicator stays on, see Table 8 on page 52.

10. Press and hold the On | button until you hear the UPS beep (approximately one second). The  $\sim$  indicator stops flashing and the load level indicators display the percentage of load being applied to the UPS.

The UPS is now in Normal mode and supplying power to your equipment.



---

**NOTE** The batteries charge to 90% capacity in approximately 3 hours. However, it is recommended that the batteries charge for 24 hours after installation or long-term storage.

**NOTE** If more than two EBMs are installed, an external battery charger is recommended for faster recharge times.

---

## UPS Rear Panels

This section shows the rear panels of the Powerware 5125 models.

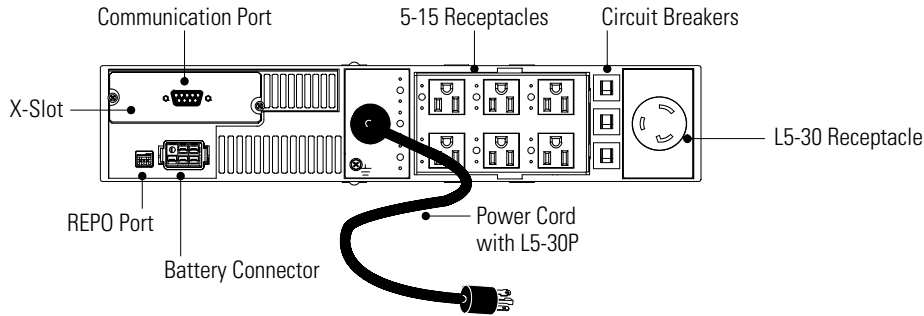

**Figure 14. 2400–3000 VA, 100/120V Rear Panel**

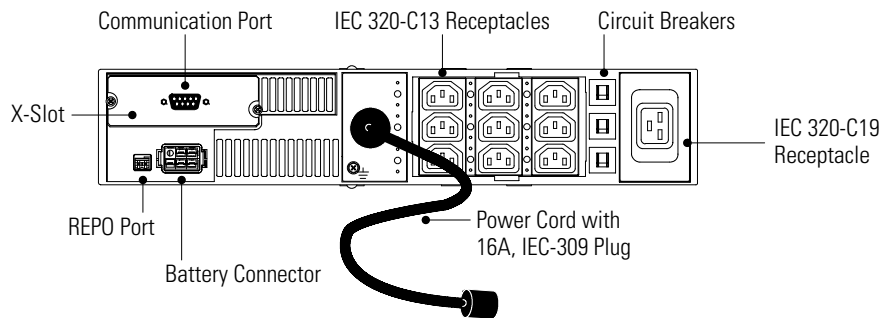

**Figure 15. 2400–3000 VA, 230V Rear Panel**

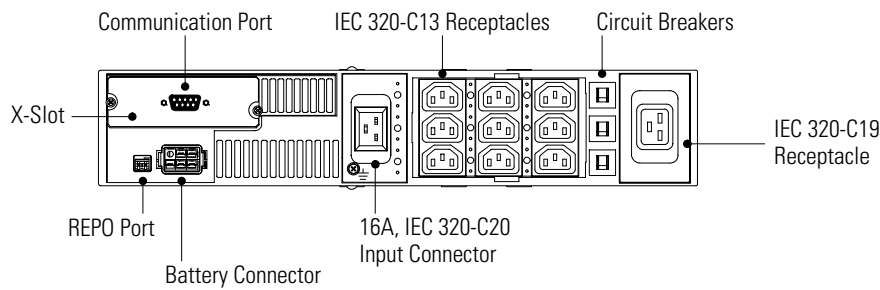

**Figure 16. 3000 VA, 230V (PW5125 3000e RM) Rear Panel**

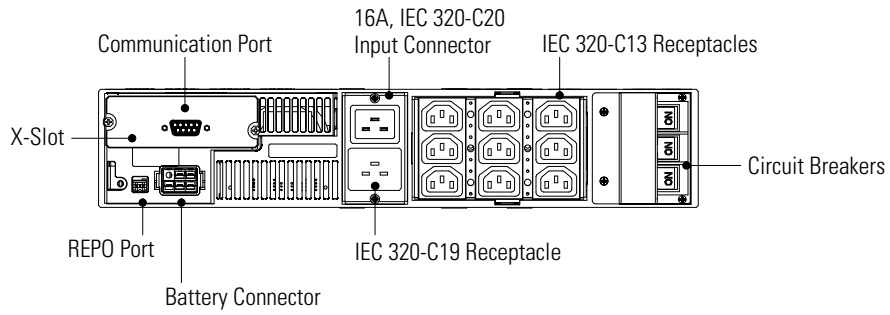

**Figure 17. 3000 VA, 200–240V (PW5125 3000g RM) Rear Panel**





## CHAPTER 4

# OPERATION

This section describes:

- Turning the UPS on and off
- Starting the UPS on battery
- Initiating the self-test
- Operating modes

### Turning the UPS On

After the UPS is connected to a power outlet, it conducts a self-test and enters Standby mode. To turn on the UPS, press and hold the On | button until you hear the UPS beep (approximately one second). The ~ indicator stops flashing and the load level indicators display the percentage of load being applied to the UPS.

#### Starting the UPS on Battery



---

**NOTE** Before using this feature, the UPS must have been powered by utility power at least once.

---

To turn on the UPS without using utility power, press and hold the On | button for at least four seconds. The UPS supplies power to your equipment and goes into Battery mode. When the UPS starts on battery, it does not conduct a self-test to conserve battery power.

### Turning the UPS Off

To turn off the UPS, press and hold the Off ⏻ button until the long beep ceases (approximately five seconds). The ~ indicator begins to flash and the UPS remains in Standby mode until you unplug the UPS from the power outlet.

## Initiating the Self-Test



**NOTE** The batteries must be fully charged and the UPS must not be in Battery mode to perform the self-test.

Press and hold the button for three seconds to initiate the self-test. During the test, individual indicators illuminate as various parts of the UPS are checked. If the alarm beeps or a UPS alarm indicator stays on, see Table 8 on page 52.

## Operating Modes

Powerware 5125's front panel indicates the UPS status through the UPS indicators. Figure 18 shows the UPS front panel indicators and controls.

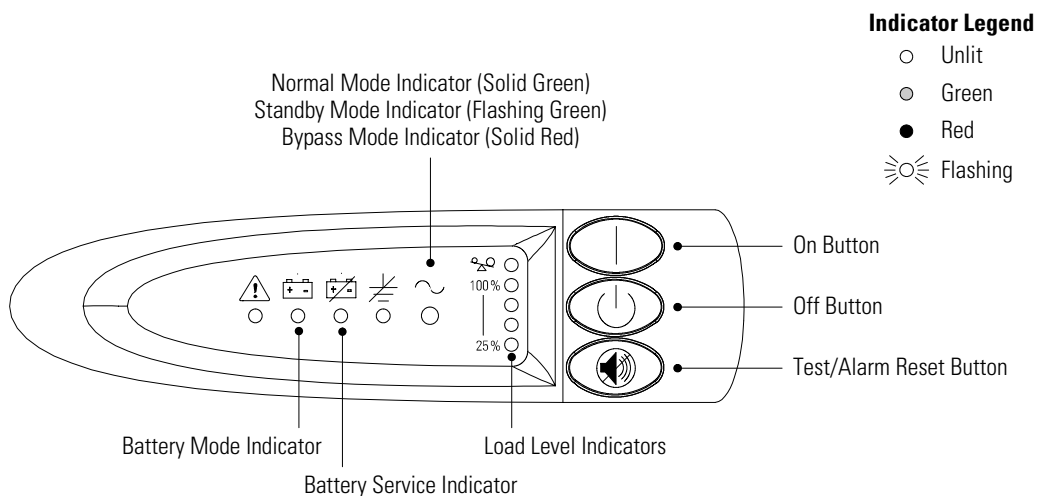

**Figure 18. UPS Front Panel**

## Normal Mode

During Normal mode, the  $\sim$  indicator illuminates and the front panel displays the percentage of UPS load capacity being used by the protected equipment (see Figure 19). The UPS monitors and charges the batteries as needed and provides power protection to your equipment.

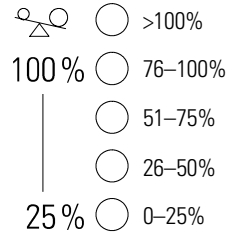

**Figure 19. Load Level Indicators**

When all of the load level indicators and the  $\sim$  indicator are illuminated, power requirements exceed UPS capacity; see page 53 for more information.

## Battery Mode

When the UPS is operating during a power outage, the alarm beeps once every five seconds and the  $\square$  indicator illuminates. When the utility power returns, the UPS switches to Normal mode operation while the battery recharges.

If battery capacity becomes low while in Battery mode, the  $\square$  indicator starts flashing and the alarm continues to beep every five seconds. Immediately complete and save your work to prevent data loss and similar difficulties. When utility power is restored after the UPS shuts down, the UPS automatically restarts.

### **Bypass Mode**

In the event of a UPS overload or internal failure, the UPS transfers your equipment to utility power. Battery mode is not available; however, the utility power continues to be passively filtered by the UPS. The alarm sounds and the  $\sim$  indicator illuminates red. The UPS switches to Bypass mode when:

- The UPS has an overtemperature condition.
- The UPS has an overload condition of 103 to 110% for 30 seconds.
- The UPS detects a fault in the battery or UPS electronics.

### **Standby Mode**

When the UPS is turned off and remains plugged into a power outlet, the UPS is in Standby mode. The  $\sim$  indicator flashes and the load level indicators are off, indicating that power is not available from the UPS output receptacles. The battery recharges when necessary.



## CHAPTER 5

# ADDITIONAL UPS FEATURES

This section describes:

- X-Slot modules
- Load segments
- Remote Emergency Power-Off

### X-Slot Modules

X-Slot modules allow the UPS to communicate in a variety of networking environments and with different types of devices. The Powerware 5125 is factory-installed with a Single-Port module and is compatible with any X-Slot module, including:

- Multi-Server Module - has six serial communication ports that can communicate with UPSs, terminals, computers, and modems.
- ConnectUPS™MX SNMP Module - has Ethernet, modem, and SNMP capabilities.
- ConnectUPS-X and -BD SNMP/WEB Adapter - has SNMP capabilities as well as monitoring through a web browser interface.
- USB Module - connects to a USB port on your computer.

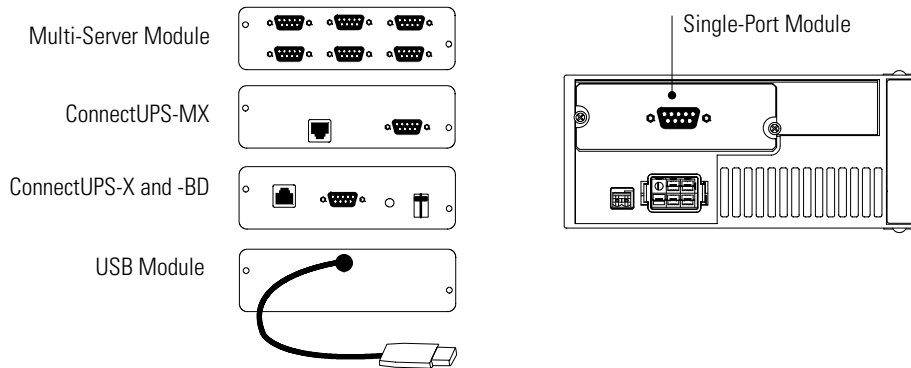

**Figure 20. Optional X-Slot Modules**

## Single-Port Module

The Powerware 5125 is factory-installed with a Single-Port Module.

To establish communication between the UPS and a computer, connect your computer to the UPS communication port using the supplied communication cable.

When the communication cable is installed, power management software can exchange data with the UPS. The software polls the UPS for detailed information on the status of the power environment. If a power emergency occurs, the software initiates the saving of all data and an orderly shutdown of the equipment.

The cable pins are identified in Figure 21 and the pin functions are described in Table 1.

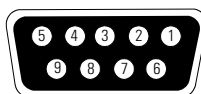

**Figure 21. Communication Port**

**Table 1. Communication Port Pin Assignment**

Pin Number	Signal Name	Function	Direction from the UPS
1	Low Batt	Low Battery relay contact	Out
2	RxD	Transmit to external device	Out
3	TxD	Receive from external device	In
4	DTR	PnP (Plug and Play) from external device (tied to Pin 6)	In
5	GND	Signal common (tied to chassis)	—
6	DSR	To external device (tied to Pin 4)	Out
7	RTS	PnP from external device (default) or On Bypass relay contact (jumper-selectable)	In / Out
8	AC Fail	AC Fail relay contact	Out
9	Power Source	+V (8 to 24 volts DC power)	Out

**The On-Bypass Relay Contact.** You can enable the On-Bypass relay using the jumper on the single-port module. The jumper default is disabled. To enable the On-Bypass relay:

1. Remove the single-port module on the UPS rear panel. Retain the screws (see Figure 22).

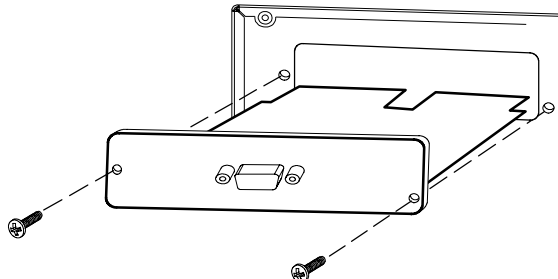

**Figure 22. Removing the Single-Port Module**

2. Move the J3 jumper to the AS/400 position to enable the On-Bypass relay as shown in Figure 23.

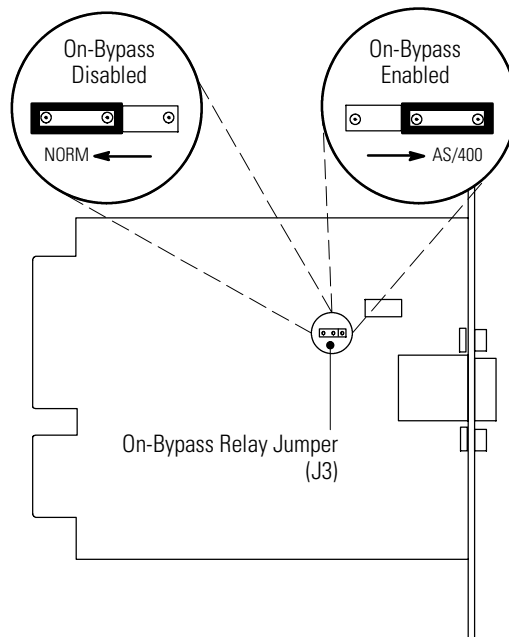

**Figure 23. On-Bypass Relay Jumper**

3. To prevent electrostatic discharge (ESD), place one hand on a metal surface such as the UPS rear panel.  
Align the single-port module with the slot guides and slide the module into the slot until it is firmly seated.
4. Secure the single-port module with the screws removed in Step 1.

## Load Segments

Load segments are sets of receptacles that can be controlled by power management software, providing an orderly shutdown and startup of your equipment. For example, during a power outage, you can keep key pieces of equipment running while you turn off other equipment. This feature allows you to save battery power. See your power management software manual for details.



**NOTE** If the power management software is not used, the individual load segments cannot be controlled.

Each UPS has three load segments as shown in Figure 24 and Figure 25.

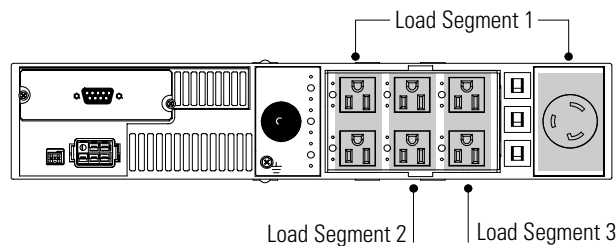

**Figure 24. UPS Load Segments (120V Model Shown)**

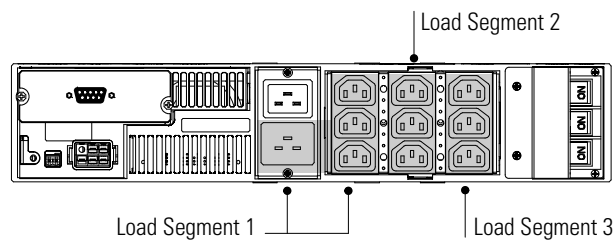

**Figure 25. UPS Load Segments (PW5125 3000g RM Model Shown)**

## Remote Emergency Power-Off

The Powerware 5125 includes a REPO port that allows power to be switched off at the UPS output receptacles from a customer-supplied switch in a remote location.

The REPO feature shuts down the protected equipment immediately and does not follow the orderly shutdown procedure initiated by any power management software.

Any devices that are operating on battery power are also shut down immediately. When the REPO switch is reset, the equipment will not return to battery power until the UPS is manually restarted.

If the Off  button is pressed after the REPO is activated, the UPS remains in Standby mode when restarted until the On | button is pressed.

### WARNING



The REPO circuit is an IEC 60950 safety extra low voltage (SELV) circuit. This circuit must be separated from any hazardous voltage circuits by reinforced insulation.

### CAUTION



To ensure the UPS stops supplying power to the load during any mode of operation, the input power must be disconnected from the UPS when the emergency power-off function is activated.



**NOTE** The REPO function activates when the REPO contacts close.

Use the following procedure to install the REPO switch:

1. Verify that the UPS is off and unplugged.
2. Remove the REPO connector from the REPO port on the rear panel of the UPS.
3. Connect isolated, normally-open, dry contacts (rated at 60 Vdc maximum, 30 Vac RMS maximum, and 20 mA maximum) across the REPO device to Pin 1 and Pin 2 (see Figure 26). Use stranded, non-shielded wiring, size 18–22 AWG (0.75 mm<sup>2</sup>–0 mm<sup>2</sup>).

4. Reconnect the REPO connector to the REPO port.

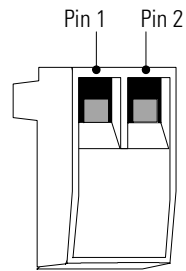

**Figure 26. REPO Connector**

5. Verify that the externally-connected REPO switch is not activated to enable power to the UPS output receptacles.
6. Plug in the UPS and start the UPS by pressing the On | button.
7. Activate the external REPO switch to test the REPO function.
8. De-activate the external REPO switch and restart the UPS.



## CHAPTER 6

# UPS MAINTENANCE

This section explains how to:

- Care for the UPS and batteries
- Replace the electronics module
- Replace the batteries
- Test new batteries
- Recycle used batteries

### UPS and Battery Care

For the best preventive maintenance, keep the area around the UPS clean and dust-free. If the atmosphere is very dusty, clean the outside of the system with a vacuum cleaner.

For full battery life, keep the UPS at an ambient temperature of 25°C (77°F).

#### Storing the UPS and Batteries

If you store the UPS for a long period, recharge the battery every 6 months by plugging the UPS into a power outlet. The batteries charge to 90% capacity in approximately 3 hours. However, it is recommended that the batteries charge for 24 hours after long-term storage.

Check the battery recharge date on the shipping carton label. If the date has expired and the batteries were never recharged, do not use the UPS. Contact your service representative.

## Replacing the Electronics Module

The electronics module can be hot-swapped for easy replacement without losing power to your equipment. The UPS automatically switches to Bypass mode. Battery mode is not available; however, the utility power continues to be passively filtered by the UPS.

Use the following procedure to replace the electronics module:

1. Disconnect the Extended Battery Module cable, the Remote Emergency Power-Off cable, and the communication cable if installed.
2. Remove the UPS front panel by pulling on both ends.

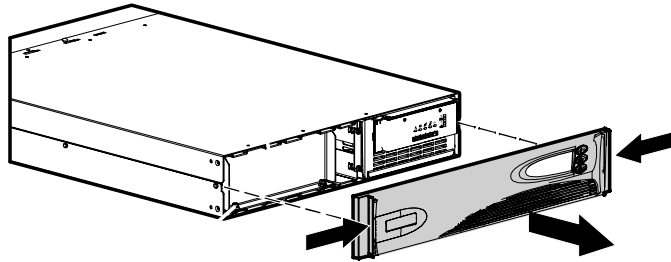

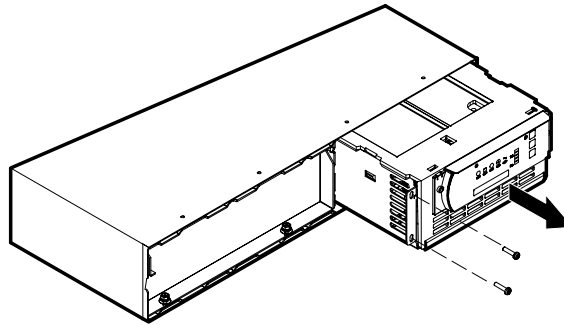

3. Remove the two screws on the left of the electronics module.



4. Remove the electronics module.
5. Replace the electronics module and secure to the UPS chassis with the screws removed in Step 3.
6. Replace the front panel.
7. Reconnect any cables removed in Step 1.

## When to Replace Batteries

When the  indicator flashes and there is a continuous audible alarm, the batteries may need replacing. Conduct a self-test by pressing and holding the  button for three seconds. If the  indicator stays on, contact your service representative to order new batteries.

## Replacing Batteries





---

**NOTE** DO NOT DISCONNECT the batteries while the UPS is in Battery mode.

---

With the hot-swappable battery feature, UPS batteries can be replaced easily without turning the UPS off or disconnecting the load.

If you prefer to remove input power to change the battery: 1) Press and hold the Off  button until the long beep ceases (approximately five seconds), then unplug the UPS; 2) Wait 60 seconds while the internal processor shuts down before you disconnect the battery.

Consider all warnings, cautions, and notes before replacing batteries.

### WARNING



- Batteries can present a risk of electrical shock or burn from high short-circuit current. The following precautions should be observed: 1) Remove watches, rings, or other metal objects; 2) Use tools with insulated handles; 3) Do not lay tools or metal parts on top of batteries.
  - ELECTRIC ENERGY HAZARD. Do not attempt to alter any battery wiring or connectors. Attempting to alter wiring can cause injury.
-

## How to Replace Extended Battery Modules

Use the following procedure to replace EBMs:

1. Unplug the EBM cable from the UPS.
2. If the UPS is in a vertical configuration, remove the EBM brackets from the top.
3. Replace the EBM. See “Recycling the Used Battery” on page 45 for proper disposal.
4. Reinstall the EBM brackets if removed in Step 2.
5. Plug the new EBM into the UPS as shown in Figure 27. Plug the other end of the EBM cable into the EBM battery connector.
6. For additional EBMs, plug the EBM cable into the battery connector of each EBM.

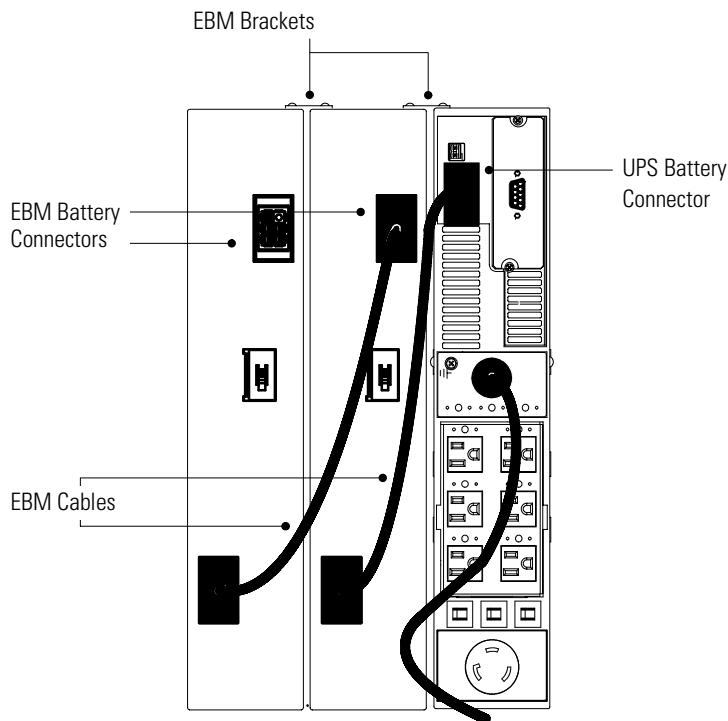

**Figure 27. EBM Connections (120V Model Shown)**

## How to Replace Internal Batteries

### CAUTION



Pull the battery out onto a flat, stable surface. The battery is unsupported when you pull it out of the UPS.

Use the following procedure to replace internal batteries:

1. Remove the UPS front panel by pulling on both ends.

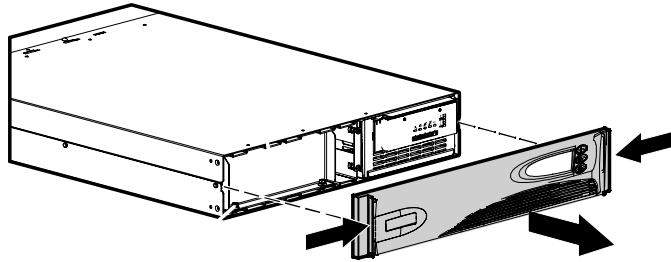

2. Unscrew and set aside the battery retaining bracket.

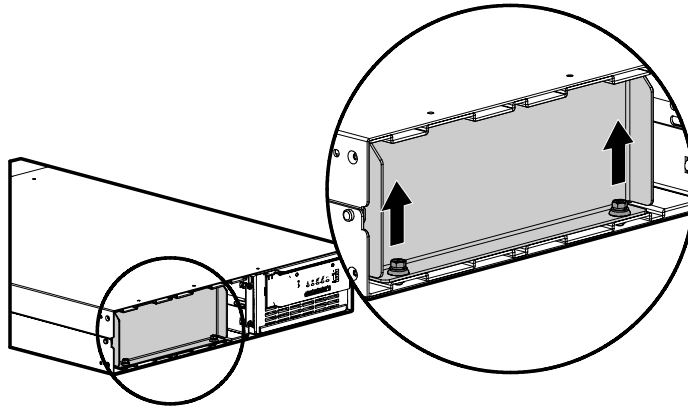

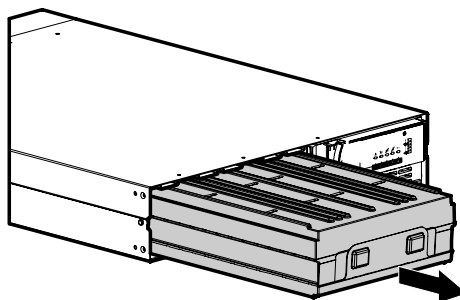

3. Pull the battery out onto a flat, stable surface. See “Recycling the Used Battery” on page 45 for proper disposal.



4. Slide the new battery into the UPS.
5. Reinstall the battery retaining bracket and screws removed in Step 2.
6. Replace the front panel.

## Testing New Batteries

Press and hold the  button for three seconds to initiate a self-test. After the test is finished, the  indicator should turn off. If the  indicator stays on, check the battery connections. Call your service representative if the problem persists.

## Recycling the Used Battery

Contact your local recycling or hazardous waste center for information on proper disposal of the used battery.



### WARNING

- Do not dispose of the battery or batteries in a fire. Batteries may explode. Proper disposal of batteries is required. Refer to your local codes for disposal requirements.
- Do not open or mutilate the battery or batteries. Released electrolyte is harmful to the skin and eyes. It may be toxic.



### CAUTION

Do not discard the UPS or the UPS batteries in the trash. This product contains sealed, lead-acid batteries and must be disposed of properly. For more information, contact your local recycling or hazardous waste center.





## CHAPTER 7

# SPECIFICATIONS

This section provides the following specifications for the Powerware 5125 models:

- Electrical input and output
- Weights and dimensions
- Environmental and safety
- Battery

**Table 2. Model Specifications**

Model Number	Power Levels (rated at nominal inputs)	Nominal Voltage	Input Voltage Range
PW5125 2400 RM	2400 VA, 2250W	120V	90–144V
PW5125 3000 RM	2880 VA, 2700W	120V	
PW5125 2400i RM	2400 VA, 2250W	230V	180–288V
PW5125 3000i RM	3000 VA, 2700W	230V	
PW5125 3000e RM	3000 VA, 2700W	230V	180–288V
PW5125 3000g RM	3000 VA, 2700W	200–240V	160–288V
PW5125 3000j RM	2400 VA, 2250W	100V	82–120V

**Table 3. Weights and Dimensions**

	UPS	EBM
Dimensions (WxDxH)	19.0" x 24.5" x 3.5" (2U) (48.3 x 62.2 x 8.9 cm)	19.0" x 24.5" x 3.5" (2U) (48.3 x 62.2 x 8.9 cm)
Weight	82 lb (37 kg)	121 lb (54.9 kg)

**Table 4. Technical Specifications**

	Low Voltage Models	High Voltage Models
Operating Frequency	50/60 Hz, auto-sensing	
Frequency Range	46–64 Hz	
Noise Filtering	MOVs and line filter for normal and common mode noise	
Input Connections	12-ft, L5-30P power cord	12-ft, 16A IEC-309 power cord PW5125 3000e and 3000g RM models: 16A, IEC 320-C20 input connector
Regulation (Normal mode)	-10% to +6% of nominal voltage	
Regulation (Battery mode)	Nominal output voltage $\pm 5\%$	
Voltage Waveform	Sine wave	
Output Receptacles	(1) L5-30R, (6) 5-15R	(1) IEC 320-C19, (9) IEC 320-C13

**Table 5. Environmental and Safety**

	Low Voltage Models	High Voltage Models
Operating Temperature	0°C to 40°C (32°F to 104°F) Optimal battery performance: 25°C (77°F)	
Storage Temperature	0°C to 25°C (32°F to 77°F)	
Transit Temperature	-25°C to 55°C (-13°F to 131°F)	
Relative Humidity	5–95% noncondensing	
Operating Altitude	Up to 2,000 meters above sea level	
Transit Altitude	Up to 15,000 meters above sea level	
Audible Noise	Less than 45 dBA Normal mode, typical load Less than 50 dBA Battery mode	
Surge Suppression	ANSI C62.41 Category B (formerly IEEE 587), IEC 61000-4-5	
Safety Conformance	UL 1778, CAN/CSA C22.2, No. 107.1	UL 1778, CAN/CSA C22.2, No. 107.1; EN 50091-1-1 and IEC 60950
Agency Markings	UL, cUL	UL and cUL; CE, TÜV-GS (model dependent)
EMC	FCC Part 15, ICES-003, VCCI	EN 50091-2, FCC Part 15, ICES-003

**Table 6. Battery**

Configuration	(10) 12V, 5 Ah internal batteries
EBM Configuration	PW5125 120 EBM: 120V, 30A
Type	Sealed, maintenance-free, valve-regulated, lead-acid
Charging	Internal battery: less than 3 hours to 90% usable capacity at nominal line voltage after full load discharge External battery: recharging at 80% load or less is recommended; no more than 16x discharge time to 90% usable capacity at nominal line voltage after full load discharge; an external charger is recommended for faster recharge times when using more than 2 EBMs.
Monitoring	Advanced monitoring for earlier failure detection and warning; auto detection of additional EBMs (if using LanSafe III Power Management Software, the EBM configurator must be used for accurate reporting of EBM battery times).

**Table 7. Battery Run Times (in Minutes at Full/Half Load)**

Model	Internal UPS Batteries	1 EBM	2 EBMs	3 EBMs	4 EBMs
2400 VA	7/19	35/73	60/124	85/177	110/229
3000 VA	5/15	25/61	49/103	69/146	90/190

**NOTE** Battery times are approximate and vary depending on the load configuration and battery charge.





## CHAPTER 8

# TROUBLESHOOTING

This section explains:

- UPS alarms and conditions
- How to silence an alarm
- Service and support

### Audible Alarms and UPS Conditions

The UPS has an audible alarm feature to alert you of potential power problems. Use Table 8 to determine and resolve the UPS alarms and conditions.

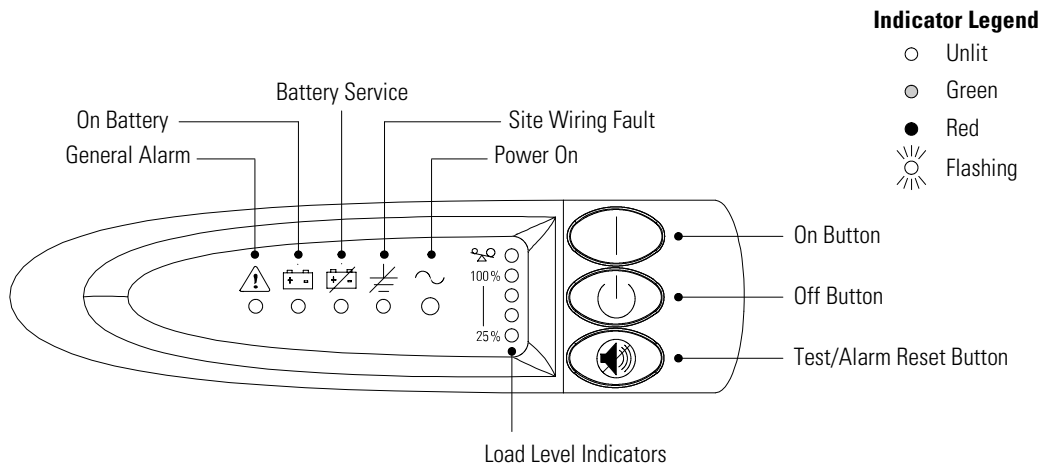



















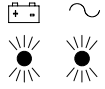







**Figure 28. Alarm Indicators**

### Silencing an Audible Alarm

To silence the alarm for an existing fault, press the  button. If UPS status changes, the alarm beeps, overriding the previous alarm silencing. The alarm does not silence if there is a low battery condition.

**Table 8. Troubleshooting Guide**

Alarm or Condition	Possible Cause	Action
The  indicator is not on; the UPS does not start.	The power cord is not connected correctly.  The wall outlet is faulty.	Check the power cord connections.  Have a qualified electrician test and repair the outlet.
The  indicator is flashing; power is not available at the UPS output receptacles.	The UPS is in Standby mode.	Press the On   button to supply power to the connected equipment.
The UPS does not provide the expected backup time.	The batteries need charging or service.	Plug the UPS into a power outlet for 24 hours to charge the battery. After charging the battery, press and hold the  button for 3 seconds; then check the  indicator. If the  indicator is still on, see “UPS Maintenance” on page 39 to replace the battery.
 Continuous audible alarm. The self-test failed.  		Plug the UPS into a power outlet for at least 3 hours to charge the battery. After charging the battery, press and hold the  button for 3 seconds; then check the  indicator. If the  indicator is still on, shut down the UPS and contact your service representative.
	UPS internal temperature is too high.	The UPS switches to Bypass mode, allowing the UPS to cool. Turn off and unplug the UPS. Clear vents and remove any heat sources. Ensure the airflow around the UPS is not restricted. Wait at least 5 minutes and restart the UPS. If the condition persists, contact your service representative.
    	The UPS is on battery.	The UPS is powering the equipment with battery power. Prepare your equipment for shutdown.
1 beep every 5 seconds.		
    	The battery is running low.	3 minutes or less of battery power remains (depending on load configuration and battery charge). Save your work and turn off your equipment. The alarm cannot be silenced.
1 beep every 5 seconds.		

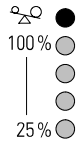
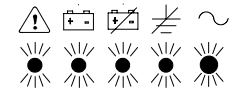
Alarm or Condition	Possible Cause	Action
 1 beep every 5 seconds.	The UPS is running on battery power because the input voltage is too high or too low.	The UPS continues to operate on battery until the condition is corrected or the battery is completely discharged. If the condition persists, the input voltage in your area may differ from the UPS nominal.
	The utility line voltage and frequency are out of specification.	Have a qualified electrician check the wiring.
 1 beep every 5 seconds.	The battery may be fully discharged.	Plug the UPS into a power outlet for 24 hours to charge the battery. After charging the battery, press and hold the  button for 3 seconds; then check the  indicator. If the  indicator is still on, shut down the UPS and contact your service representative.
	The battery is not connected correctly.	Check the battery connections. Call your service representative if the problem persists.
 1 beep every 5 seconds.	Ground wire connection does not exist or the line and neutral wires are reversed in the wall outlet.	Have a qualified electrician correct the wiring.
 1 beep every 5 seconds.	Bypass is not available. Input voltage is not within $\pm 12\%$ of nominal or input frequency is not within $\pm 3\%$ of nominal.	The UPS is receiving utility power that may be unstable or in brownout conditions. The UPS continues to supply power to your equipment. If conditions worsen, the UPS may switch to battery power.
	UPS is in Bypass mode.	The equipment is transferred to utility power. Battery mode is not available; however, the utility power continues to be passively filtered by the UPS. Check for one of the following alarms: Overtemperature, Overload, UPS Failure, or Battery Service.
 100% ● ● ● 25% ●	Power requirements exceed UPS capacity (103 to 110% for 30 seconds) or the load is defective.	Turn off and unplug the UPS. Remove some of the equipment from the UPS. Wait at least 5 seconds until all LEDs are off and restart the UPS. You may need to obtain a larger capacity UPS.
	UPS fault condition.	Save your work and turn off your equipment. Turn off and unplug the UPS. Contact your service representative. The alarm cannot be silenced.

## Service and Support

If you have any questions or problems with the UPS, call your **Local Distributor** or the **Help Desk** at one of the following telephone numbers and ask for a UPS technical representative.

In the United States: **1-800-356-5737** or **1-608-565-2100**

Europe, Middle East, Africa: **+44-17 53 608 700**

Asia: **+852-2830-3030**

Australia: **+61-3-9706-5022**

Please have the following information ready when you call the Help Desk:

- Model number
- Serial number
- Version number (if available)
- Date of failure or problem
- Symptoms of failure or problem
- Customer return address and contact information

If repair is required, you will be given a Returned Material Authorization (RMA) Number. This number must appear on the outside of the package and on the Bill Of Lading (if applicable). Use the original packaging or request packaging from the Help Desk or distributor. Units damaged in shipment as a result of improper packaging are not covered under warranty. A replacement or repair unit will be shipped, freight prepaid for all warranted units.



---

**NOTE** For critical applications, immediate replacement may be available. Call the **Help Desk** for the dealer or distributor nearest you.

---