

■ Operator's Manual

■ *Alpha CFR 1500, CFR 2000,
CFR 2500, and CFR 3000*

UNINTERRUPTIBLE POWER SUPPLIES

FROM ALPHA TECHNOLOGIES

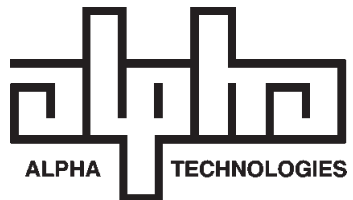

■ Operator's Manual

■ Alpha *CFR 1500, CFR 2000, CFR 2500, and CFR 3000*

UNINTERRUPTIBLE POWER SUPPLIES

IMPORTANT SAFETY INSTRUCTIONS CONTAINED IN THIS MANUAL



CAUTION: To reduce the risk of electrical shock, and to ensure the safe operation of this unit, the following symbols have been placed throughout the manual. Where these symbols appear, servicing should be performed only by qualified personnel.



Dangerous Voltage

A dangerous voltage exists in this area.
Use extreme caution.



Attention

Important operating instructions.
Follow these instructions closely.

WARNING:

To reduce the risk of fire and shock hazards, do not expose this unit to rain or moisture.

SAVE THESE INSTRUCTIONS

This manual contains important installation and operating instructions. Keep this manual in a safe place.

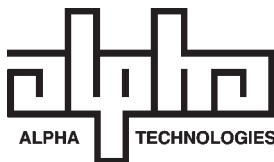



IMPORTANT SAFETY PRECAUTIONS



Carefully unpack the unit. Report any shipping damage immediately.

Please read the operators manual. If you have any questions regarding the safe installation of the unit, contact Alpha Technologies.

The unit should be serviced only by qualified personnel.

The unit contains more than one live circuit. Even though AC is not present at the input, it may be present at the output.

Always switch the battery circuit breaker to off before connecting or disconnecting an external battery pack. This greatly reduces the chance of spark.

For units with a detachable AC line cord, connect a dedicated grounding wire (14 AWG/ 2.0 MM²) from the ground lug on the back of the unit to an electrical ground point. This will provide a safety ground connection to the unit and all of its attached equipment, even when the AC line cord is unplugged.

The connections on the back of this unit are not for use with telephone network connections.

The standard unit, with line cord and receptacles, may be installed by a non-technical user.

Units equipped with terminal block input or output connectors, or external battery packs, must be installed by qualified service personnel in accordance with the following table:

MODEL	TERMINAL BLOCKS		TIGHTENING TORQUE	
	<u>AWG</u>	<u>mm²</u>	<u>Inch Pounds</u>	<u>Newton Meters</u>
1500-2500 (60Hz)	14	2.0	35	4.0
3000 (60Hz)	12	3.0	35	4.0
2000-3000 (50Hz)	16	1.5	35	4.0

When not in service, the batteries should be charged at least once every three months to ensure optimum performance and battery life. For standard units, simply plug the units' power cord into a wall receptacle and leave it running for one to three days.

The unit should be installed upright in a well ventilated area that is free of dust and moisture.

Alert Fire or Emergency personnel that an uninterruptible power supply is installed in the building by placing a notification or warning label on the electrical panel.

When connecting a load to the unit's rear panel, do not exceed the output rating of the unit.



IMPORTANT SAFETY PRECAUTIONS



The CFR 1500-3000 Series units contain sealed, Lead-Acid batteries consisting of:

Four batteries, six cells each, 48 VDC total.

WARNING: Batteries contain high energy and chemical hazards. Carefully read this manual regarding safe battery handling, maintenance and disposal instructions. Inspection and replacement should be performed only by qualified personnel.

Wear insulated gloves and eye protection whenever working inside the battery compartment.

Do not allow live battery wires to contact the unit's chassis. Shorting battery wires could result in a fire or possible explosion.

Batteries should be inspected every year for signs of cracking, leaking, or signs of swelling.

Always replace batteries with those of an identical type and rating. Never install old or untested batteries.

Avoid using uninsulated tools or other conductive materials when handling batteries or working inside the unit.

Remove all rings, watches and other jewelry before servicing batteries.

Spent batteries are considered environmentally unsafe. Always recycle batteries..

Verify the voltage requirements of the equipment to be protected (load), the AC input to the UPS (Line), and the output voltage of the UPS prior to installation.

The utility service panel should be equipped with a circuit breaker that is rated (Amperage) for use with the UPS

Use proper lifting techniques whenever handling the UPS or an external battery pack.

Table of Contents

The Alpha CFR 1500, CFR 2000, CFR 2500, and CFR 3000 Uninterruptible Power Supplies

1.	INTRODUCTION	1
1.1	The Alpha CFR	1
1.2	The CFR Advantage	2
1.3	Unpacking and Inspection	4
2.	FEATURES	5
2.1	A Tour of the CFR	5
2.2	CFR Front Panel	5
2.3	CFR Rear Panel	6
2.4	Information Management Options	8
	<i>Standard Interface Device</i>	
	<i>Intelligent Interface Device</i>	
	<i>External Modem</i>	
2.5	Communication / Interface Options	10
	<i>RS-232 Monitoring / Control Applications</i>	
	<i>Rear Panel Connectors</i>	
	<i>RS-232 Connector</i>	
	<i>Standard CFR-UPS</i>	
	<i>Desktop IID</i>	
	<i>LAN Interface Connector</i>	
	<i>External IID Connector</i>	
	<i>External Alarms Connector</i>	
	<i>EPO Emergency Power OFF Switch</i>	
3.	INSTALLATION	17
3.1	Pre-Installation	17
	<i>Site Preparation</i>	
	<i>Utility Circuit Breaker</i>	
	<i>Grounding</i>	
	<i>Standby Generators</i>	
3.2	Connecting the CFR	18
3.2.1	Terminal Block Input and Output	19
3.3	External Battery Pack	21
3.4	208VAC/240VAC Configurations	22
4.	OPERATION	25
4.1	Start-up and Test	25
	<i>Manual Self-test</i>	
	<i>Audible Alarm OFF</i>	
	<i>Manual Start (No AC Line Power)</i>	
	<i>Switching OFF the UPS</i>	

Table of Contents, *continued*

4.	OPERATION, <i>continued</i>	
	4.2 Using the Standard Interface Device	28
	<i>UPS Powering Up</i>	
	<i>Output Shutdown Pending</i>	
	<i>Output Shutdown in Progress</i>	
	<i>Line Present Operation</i>	
	<i>Line Failure (AC Input Out of Tolerance)</i>	
	<i>Line Failure Operation</i>	
	<i>Line Synchronization</i>	
	<i>Low Battery Warning</i>	
	<i>Low Battery Shutdown</i>	
	<i>Test</i>	
	<i>Service</i>	
	<i>Alarm Off Switch</i>	
	<i>Manual Start / (Hold to Test) Switch</i>	
	<i>Output Load Display</i>	
5.	RS-232 TERMINAL COMMUNICATION	33
	5.1 Remote RS-232 Operation	33
	5.2 RS-232 Menu Selection Icons	34
	5.3 Remote Terminal Quick Reference	35
	5.4 Menu Commands Overview	36
	5.5 System Parameters	37
	5.6 Input Parameters	38
	5.7 Output Parameters	38
	5.8 Battery Parameters	40
	5.9 User Parameters	40
	5.10 Maintenance Parameters	45
	5.11 Parameter DUMP Command	47
	5.12 Event Descriptions	48
	5.13 RS-232 Terminal Setup	52
6.	MAINTENANCE	53
	6.1 CFR Maintenance	53
	6.2 Battery Maintenance	53
	6.3 Battery Testing	54
	6.4 Removing the CFR Front Panel and Cover	55
	6.5 Internal Battery Replacement	56
	6.6 Troubleshooting Guide	59
	6.7 Troubleshooting Using The SID	61
	6.8 Repair Instructions	63
	6.9 Parts and Ordering Instructions	63
7.	SPECIFICATIONS	64
	7.1 Specifications	64
8.	WARRANTY	66

IMPORTANT: EMERGENCY SHUTDOWN PROCEDURE ON INSIDE BACK COVER

1.1 The Alpha CFR

Congratulations on your purchase of one of the most advanced and intelligent Controlled Ferroresonant-Uninterruptible Power Supplies (CFR-UPS) in the world! The Alpha CFR is designed to keep your equipment operating, regardless of the condition of your utility power. This means that your vital equipment will no longer be affected by spikes, surges, sags, noise, brownouts, blackouts or other forms of electrical disturbances. Operation is as simple as plugging your equipment into the back of the UPS and switching on the power.

The CFR provides you with a wide range of power management options using your choice of interface devices. The Standard Interface Device displays vital UPS operating parameters, including Alarms, and allows you to manually self-test the UPS. The Intelligent Interface Device provides you with precise Voltage, Current and Frequency information, plus maintains an on-going record of all Alarm and Line Failure Events. As an active center of communication, your CFR can also be interfaced directly to your computer system to inform you, and your users, of changes in status as they occur.

With distribution networks and service centers located throughout the world, Alpha Technologies is here to back you up. From your date of purchase, Alpha provides complete technical support and prompt, reliable service to ensure that your CFR-UPS provides you with a lifetime of reliable operation.



The Alpha CFR-UPS provides regulated, current-limited, output with excellent isolation and noise attenuation.

1. INTRODUCTION

1.2 The CFR Advantage

ADVANCED POWER PROTECTION TECHNOLOGY

Power protection devices can be judged by the type and quality of power they provide. Alpha CFR Uninterruptible Power Supplies provide continuous, conditioned "computer-grade" AC power to electronic equipment such as Computer Systems, Point of Sale Terminals, Process Controls, Telecommunications, Cable TV Headend, Broadband LAN, Manufacturing Control Systems, Critical Care and Hospital Lab Equipment.

SURGE AND SPIKE REJECTION

Alpha's proven design virtually eliminates surges and spikes. The Alpha CFR UPS provides spike attenuation of 2000 to 1 and meets the requirements of IEEE 587 / ANSI 62.41.

REGULATION

Unlike many standby power systems which regulate output voltage only when operating from their battery backup, the Alpha CFR UPS constantly maintains $\pm 1\%$ output regulation without using precious battery power. Even with input voltage fluctuations as great as +10% or -25%, the output remains constant, regardless of load.

ISOLATION

Electromagnetic and Radio Frequency Interference (EMI and RFI) can damage semiconductors and have devastating effects on critical data. The CFR UPS input is *totally isolated* from the output to provide maximum protection from this type of interference. Measured in decibels (dB) of attenuation, Alpha's CFR achieves up to 120 dB common mode, and 60 dB normal mode.

EXTENDED BACKUP CAPABILITY

Alpha's EBP Series External Battery Packs allow you to greatly extend your backup capabilities and power through long utility outages. Completely self-contained and pre-wired, simply plug the EBP cabinet into your CFR and forget about it. EBP Series External Battery Packs can also be ordered with an optional, external charger to greatly reduce battery recharge times.

1.2 The CFR Advantage, *continued*

COMMUNICATIONS AND INTELLIGENCE

Alpha's interchangeable Standard Interface Device and Intelligent Interface Device allow your CFR to become an active part of your communications network providing you with a variety of interface options.

SELF-TEST CAPABILITIES

The CFR has a built-in, self-test function that checks all critical areas of the UPS, including the batteries, to ensure optimum performance. Whenever a problem is detected, the UPS lights a "Service" indicator. Self-test is extremely useful during troubleshooting and maintenance.

PRECISE LOAD & OVERLOAD INFORMATION

The Alpha CFR provides vital load information to eliminate guess work associated with matching the appropriate load to your unit. The Alpha CFR displays the existing load and, whenever the load exceeds the rated output, an "Overload" indicator is illuminated.

GENERATOR READY

The CFR UPS is equipped with a frequency sense circuit, along with a constant slew frequency synchronization circuit, to provide trouble-free operation with most standby generators.

SAFETY

Designed to meet or exceed the safety standards established by UL, CSA and VDE, the Alpha CFR UPS is one of the safest, most reliable and versatile uninterruptible power supplies available. Our commitment to safety and quality engineering has not only established industry-wide safety standards, but has earned Alpha Technologies international recognition as a leader in power protection equipment.

1. INTRODUCTION

1.3 Unpacking and Inspection

Carefully remove the UPS from its shipping container. Inspect the contents. If items appear to be damaged or missing, contact Alpha Technologies and the shipping company immediately. Most shipping companies have only a short claim period. Make sure the following items have been included:

1. CFR Series UPS with AC Line Cord
2. Operator's Manual
3. Any other ordered options

SAVE THE ORIGINAL SHIPPING CONTAINER.

In the event the UPS needs to be returned for service, it should be packaged in its original shipping container. If the original container is not available, make sure that the unit is packed with at least three inches of shock-absorbing material to prevent shipping damage. **NOTE:** Do not use popcorn-type material. Alpha Technologies is not responsible for damage caused by the improper packaging of returned units.

PLEASE READ THE OPERATOR'S MANUAL.

Become familiar with the UPS front and rear panels. Review the drawings and illustrations before proceeding with the UPS installation. If you have questions regarding the safe installation or operation of the UPS, contact Alpha Technologies.

COMPLETE THE FOLLOWING FOR YOUR RECORDS:

Model # _____
Serial # _____
Options _____
Purchase date _____

THIS UNIT WAS PURCHASED FROM:

Dealer name _____
City _____
State/Province _____
Zip/Postal Code _____
Country _____
Telephone # _____

2.1 A Tour of the CFR

The Alpha CFR is designed to be easy to use and extremely flexible. The CFR's interchangeable front panel interface devices provide you with a wide range of information management options. The rear panel accepts a variety of connectors and receptacle plates to facilitate your most demanding communication and powering needs.

2.2 The CFR Front Panel

The CFR front panel comes equipped with a Standard Interface Device (SID), or an optional Intelligent Interface Device (IID), to display vital UPS operating parameters. The front panel can be easily removed for service or battery access by loosening the two screws located in the lower grill.

Standard Interface Device



Panel Screws

Fig.1
CFR Front Panel

2. FEATURES

2.3 CFR Rear Panel

1. AC LINE Cord

The UPS is equipped with a standard, grounded AC line cord.

2. EXTERNAL BATTERY Connector

The connector accepts a standard plug from the EBP Series Battery Pack. Extending backup time is as simple as plugging in the battery pack.

3. BATTERY Circuit Breaker

The battery breaker protects the DC circuit. When the UPS is not in service, the breaker should be switched OFF to preserve the batteries in the UPS and in the EBP Series Battery Pack, if installed (see section 4.1 "UPS Shutdown").

4. External Ground Lug (Single Point Ground)

The external ground lug provides a single point connection for optimum grounding protection. Always refer to your local electrical codes for prescribed grounding practices.

5. UPS Nameplate Label

The nameplate label contains valuable information relating to the UPS. Always verify input voltage and frequency (i.e., 120 VAC / 60 Hz) before use.

6. RS-232 Serial Connector (DE-9 Female Connector)*

The standard RS-232 serial interface allows for connection to a host computer/ dumb terminal for remote monitoring, control and calibration of the UPS. Use a straight through serial cable to connect the UPS to the computer.

7. LAN Interface Connector (DE-9 Female Connector)

The LAN Interface connector provides dry contact status monitoring and output shutdown capability on a DE-9 female connector and is used by basic UPS monitoring software for orderly shutdown of computer networks.

8. Modem Connection

Available as an option on 60Hz Models only.

9. External IID Connector (MMJ Connector)*

This connector is used for the optional desktop Intelligent Interface Device (IID) for remote monitoring and control of the UPS (up to 2000 ft.).



NOTE: This port is disabled by the factory unless an internal IID is installed.

10. External Alarms Connector (RJ-45 Connector)

This provides dry contact closure alarm status on a RJ-45 (center keyed) connector, indicating LINE FAIL and LOW BATTERY WARNING.



***NOTE:** With the SID installed in the UPS, either the External IID port or the RS-232 port can be activated. The factory default is set for RS-232 operation. With the internal IID option installed in the UPS *both* ports are active.

2.3 CFR Rear Panel

11. Exhaust Fan

The UPS contains a rear panel exhaust fan to ensure maximum cooling protection during all modes of operation.

12. OUTPUT Receptacle Plate

The load (equipment to be protected) connects to the rear panel output receptacles. Styles vary depending upon country, frequency and voltage.

13. AC OUTPUT Circuit Breaker

The resettable breaker provides additional output protection to the load.

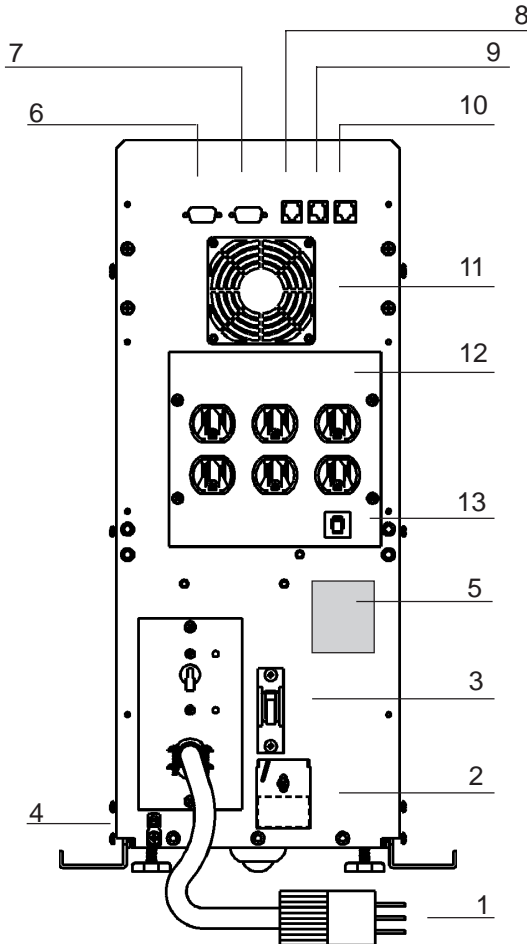

Fig. 2
CFR 1500, CFR 2000, CFR 2500, and CFR 3000 Rear Panel

2. FEATURES

2.4 Information Management Options

Standard Interface Device

The Standard Interface Device provides you with vital UPS operating parameters from front panel LEDs (see section 4.2). The Standard Interface also has a load indicator to help you determine precise loading on your UPS, plus Manual Start and Alarm Off switches. To ensure optimum backup performance, the Standard Interface comes with a self-test feature which lights the "Service" LED whenever a problem is detected.



Fig. 3
CFR Front Panel with Standard Interface Device

2.4 Information Management Options, *continued*

Intelligent Interface Device (optional)

The Intelligent Interface Device (IID) option is available either as a replacement of the Standard Interface Device (SID) or as a desktop unit for remotely accessing the unit (up to 2000 ft.). The desktop unit comes with an optional modem for accessing the UPS information via a telephone line. The IID front panel provides precise UPS information and guides you through the various menu options which include Ambient Battery Temperature, Input Voltage and Current, Line Frequency, Output Voltage and Current, Power in Watts, Power Factor, Battery Voltage, Charger Status, and more. The History Log maintains an on-going record of UPS alarms and power anomalies by time, date and type of occurrence. Whenever a UPS alarm condition occurs, such as Line Failure, Low Battery Warning, Low Battery Shutdown or Service, it is displayed by the front panel indicators and recorded in the History Log.

External Modem (option available on 60Hz models only)

The optional modem that comes with the desktop IID provides access to the unit via a phone line. Service personnel can dial up the unit to remotely monitor, control, and calibrate the unit. On specified alarm conditions, the unit can dial an emergency number to notify the system manager via modem of the alarm. The modem option may also be used to page service personnel on critical alarm conditions.



For further information on operation and installation of the IID, please refer to its operator's manual "Information Management Using the Intelligent Interface Device."



Fig. 4
Intelligent Interface Device

2. FEATURES

2.5 Communication / Interface Options

The CFR is equipped with four rear panel jacks for communication and remote interfaces: RS-232 Serial data; LAN Interface; External IID and External Alarms. Units with the external modem option have a fifth connector for modem connection.



NOTE: With the SID installed in the UPS, either the External IID port *or* the RS-232 port can be activated. The factory default is set for RS-232 operation. With the internal IID option installed in the UPS *both* ports are active.

RS-232 Monitoring / Control Applications

The Alpha CFR-UPS provides a standard RS-232 serial port on a DE-9 female connector. This port may be used to monitor and control the CFR using 1) ASCII terminals, 2) UPS monitoring software and 3) SNMP agent devices.

You may use the serial port to interface with a dumb terminal or a personal computer (running a terminal emulation software) to monitor, control, and calibrate the CFR. All you need is a standard off-the-shelf RS-232 cable (straight through) and a terminal. Refer to section 5 “RS-232 TERMINAL COMMUNICATION” for more information.

You may also use the RS-232 serial port to communicate with the intelligent UPS monitoring software running on a host computer or a SNMP agent device connected to your LAN network. Alpha Technologies provides the “AlphaNet C” family of UPS monitoring software and SNMP agents to manage your network requirements. You can use the “AlphaNet C shutdown software” to monitor the CFR in a network environment and to perform an orderly system shutdown when the battery becomes low (during extended line fail situations). AlphaNet C shutdown software informs all workstations of pending power failures and shutdowns and in multi-server networks, AlphaNet can shutdown other servers in the network as well as the workstations. For a full description of the features and capabilities of AlphaNet C shutdown software, refer to its user’s manual or contact Alpha Technologies. AlphaNet C is available for all major network platforms and operating systems — Novell Netware, SCO Unix, IBM OS/2, IBM AIX, Sun Solaris, Hewlett-Packard HP-UX (DAT), and Digital Equipment (OS/F, VMS, and DECNET).

Alpha Technologies also provides the “AlphaNet CS SNMP Agent Device” to monitor and control the CFR using the SNMP protocol. This provides an interface between the CFR and your network environment and allows you to use your Network Management Station (NMS) to monitor and control the CFR. To obtain detailed information on SNMP management solutions for your CFR refer to *AlphaNet CS SNMP Agent User’s Manual* or contact Alpha Technologies.

2.5 Communication / Interface Options, *continued*

Rear Panel Connectors:

Below are the various communication connectors as they appear on the back of the CFR-UPS. The photographs show the pin numbering for the different connector types.



NOTE: Use only fully shielded cables to make connections to any of the DE-9 connectors (RS-232 port or LAN interface).



RS-232 Serial Connector



LAN Interface Connector



External IID Connector



External Alarms Connector

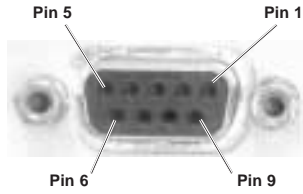

DE-9 Connector (RS-232 and LAN)

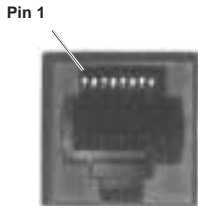

RJ-45
(External Alarms)

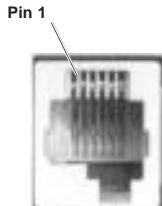

MMJ
(External IID)

Fig. 5
CFR-UPS Connector Identification and Pin-out

2. FEATURES

2.5 Communication / Interface Options, *continued*

RS-232 Connector:

The connection/specifications for the RS-232 serial port vary depending on the installed interface device (i.e., SID or IID option).

RS-232 connection for the standard CFR-UPS (with SID or internal IID display)

The standard CFR-UPS configuration with SID or internal IID connects to a computer or terminal using a standard straight-through RS-232 cable.



Fig. 6
CFR-UPS RS-232 Connector

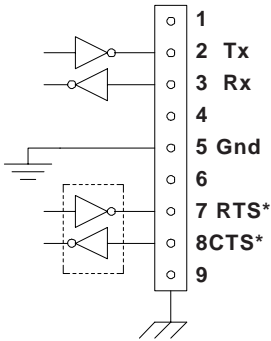

Internal CFR connections
***IID Only (Not used with SID)**

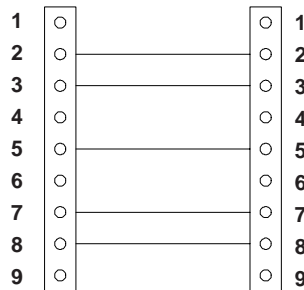

RS-232 cable to computer or terminal
Use standard straight through type

Communication Settings with IID:

Baud Rate: 300 to 9600
Parity: None, Even, or Odd
Stop Bits: 1 or 2
Data Bits: 7 or 8
Handshaking: RTS/CTS

Communication Settings with SID:

Baud Rate: 1200
Parity: None
Stop Bits: One
Data Bits: 8
Handshaking: XON / OFF

2.5 Communication / Interface Options, *continued*

RS-232 Connections with desktop IID:

With the desktop IID the cable connecting the computer or terminal to the UPS is a nonstandard type.



Fig. 7
CFR-UPS RS-232 Connector

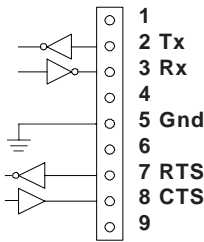

Internal CFR connections

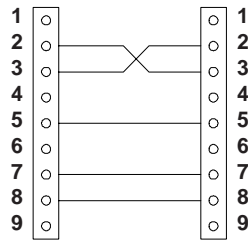

**RS-232 cable to
computer or terminal**

For the desktop IID use a nonstandard cable type

Communication Settings with IID:

- Baud Rate: 300 to 9600
- Parity: None, Even, or Odd
- Stop Bits: 1 or 2
- Data Bits: 7 or 8
- Handshaking: RTS/CTS

2. FEATURES

2.5 Communication / Interface Options, *continued*

LAN Interface Connector

The Alpha CFR-UPS provides a LAN interface port on a DE-9 female connector. This port may be used to monitor the status of the UPS and shutdown the output using basic UPS monitoring and shutdown software.

Two dry contacts are provided to indicate LINE FAIL and LOW BATTERY status information. The port also accepts a dry contact input or an RS-232 level input to shutdown the UPS output. The shutdown delay, duration, and recovery modes can be configured using the RS-232 ASCII terminal commands (see section 5 "RS-232 Terminal Communication"). This port has the following pin out:

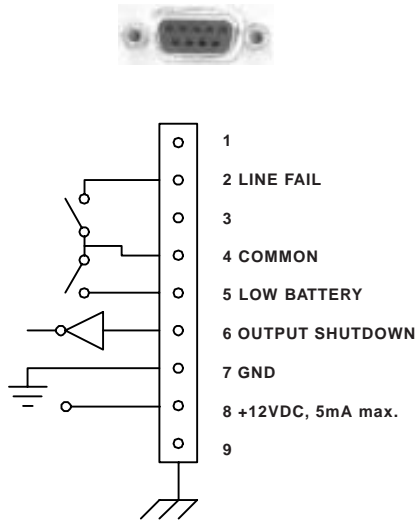

Fig. 8
Pin out: (DE-9 connector), Female

Using basic UPS monitoring software you can monitor and shutdown the CFR through this port. In network applications, your UPS monitoring software can perform an orderly shutdown on the network. Basic UPS monitoring software is provided as part of many operating systems and can also be purchased from third party vendors. Alpha Technologies "AlphaNet C shutdown software" can also operate in the basic mode to shutdown the CFR before its battery reserve is exhausted. Refer to *AlphaNet C Shutdown Software User's Manual* or contact Alpha Technologies for more information.

2.5 Communication / Interface Options, *continued*

External IID Connector

The external IID connector provides an interface for the optional desktop Intelligent Interface Device (IID). This allows the CFR to be remotely monitored and controlled from up to 2,000 feet away. The port uses a proprietary RS-485 protocol and has the following pin out:

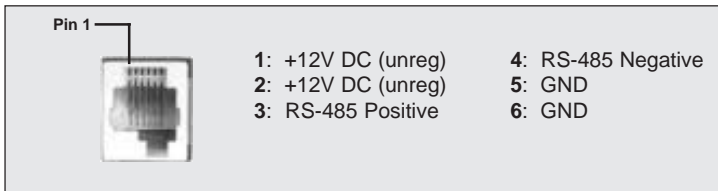

Fig. 9

Pin out: (MMJ connector, offset key)

Modem (optional configuration with Intelligent Interface Device; available on 60 Hz models only)

When the CFR UPS is equipped with an Intelligent Interface Device (IID), an internal modem can be installed to provide long-range communications. A standard modular telephone cable is used to connect the CFR modem jack to the wall jack. For further information, refer to the Intelligent Interface Device manual.

External Alarms Connector

The external alarms connector provides two contact closures to indicate LINE FAIL and LOW BATTERY alarms.

EPO (Emergency Power OFF) Switch *(Factory Installed Option)*



Pins 7 and 8 of the ALARM INTERFACE connector provide EMERGENCY POWER OFF contacts. A switch contact can be hard-wired to the UPS to completely shut down the system in the event of an emergency, such as a fire.

In an emergency, the switch must be depressed (shorted) for at least 1.5 seconds. The UPS will shut down approximately 2 seconds after the signal is recognized. The switch, connected to pins 7 and 8, must be electrically isolated (up to 1500 VAC isolation is recommended). A system shut down in this manner will open the BATTERY circuit breaker.



CAUTION: When the EPO switch is activated, the AC line connected to the UPS input may still be energized. To completely remove the power from the building, the MAIN AC line breaker in the building must be switched OFF. Consult your national and local electrical codes for further information.

2. FEATURES

2.5 Communication / Interface Options, *continued*

External Alarms Connector, *continued*

Pin out: (RJ-45 connector, centered key)

Pin 1



Low Battery Warning

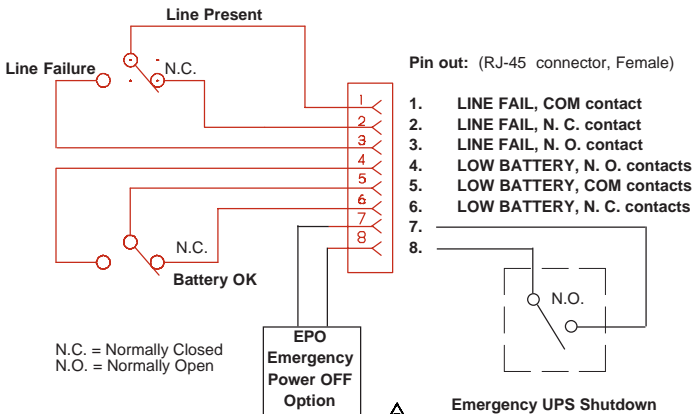

Pin out: (RJ-45 connector, Female)

1. LINE FAIL, COM contact
2. LINE FAIL, N. C. contact
3. LINE FAIL, N. O. contact
4. LOW BATTERY, N. O. contacts
5. LOW BATTERY, COM contacts
6. LOW BATTERY, N. C. contacts
- 7.
- 8.

Emergency UPS Shutdown
Switch (Wall Mounted).

NOTE: Cable length must not
exceed 100 feet. Use twisted
or shielded wire.

External Alarms Connector Pin-out (with factory installed EPO Switch Option)

3.1 Pre-Installation



Do not connect the UPS to a line conditioner, isolation transformer or any similar type of device. Damage to the UPS and the line conditioning equipment can occur.

Site Preparation

The UPS should be installed upright in a well-ventilated, dust free environment. The weight of the UPS, especially if it has an optional battery pack, is quite heavy (see specifications). Do not place the unit on any surface unable to fully support its weight.

The CFR 3000 has two leveling feet at the back panel which should be used to stabilize the unit.



Utility Circuit Breaker

The UPS should be installed on a dedicated circuit with a properly sized circuit breaker. Breaker size can be determined by adding 15% to the maximum input current of the unit (see specifications). For example, the CFR2000 draws 14.6 Amps of current when configured at 120VAC. By adding 15%, the number becomes 16.8 Amps. In this case, a standard 20 Amp circuit breaker is suitable for use.

Grounding

Since the CFR UPS bonds output neutral to ground (qualifying it as a "separately-derived power source"), proper grounding is critical. Many older facilities may have an electrical system that is incapable of supporting this type of grounding requirement. To ensure optimum performance from your UPS, always install a hardwired ground. A qualified electrician should also inspect the existing wiring in the building prior to installation to verify proper grounding.

Standby Generators

The CFR is equipped with a frequency sense circuit, along with a constant slew frequency synchronization circuit, to optimize operation with most standby generators. Prior to installation, compare the output voltage of the generator to the voltage requirements of the UPS (see CFR nameplate label). If the UPS requires 240 VAC input and the generator produces only 208 VAC, it will cause the UPS to run continuously off of battery power. This would discharge the UPS batteries and cause the output load to fail.

Alpha Technologies recommends using a generator equipped with an electronic speed and voltage control. If a generator equipped with a mechanical governor "speed control" is used, this could also cause the UPS to run continuously in LINE FAILURE mode due to the unstable frequency of the generator.

The generator should also produce less than 10% voltage THD. Generators with a higher THD rating may cause the CFR UPS to switch to LINE FAILURE mode, and switch to battery operation, as the generator output would be sensed as a noisy utility.

3. INSTALLATION

3.2 Connecting the CFR (Plug & Receptacle)

1. Connect a dedicated ground wire from the GROUND lug on the back of the CFR to an electrical ground point (i.e., wall receptacle ground or a copper water pipe). The wire size must be at least 12 AWG (3mm²).



NOTE: Most electrical codes require this type of ground connection in case the AC line power cord is disconnected from the wall. Always consult your local electrical code to ensure prescribed grounding practices.

2. Connect the CFR's AC power cord to the wall receptacle.
3. If using an external battery pack, plug its connector into the rear panel of the UPS (see section 3.3).
4. Start and test the UPS without the load connected (see section 4.1). After testing, switch the unit OFF before connecting the load.
5. Plug the equipment to be protected into the UPS rear panel receptacles.



NOTE: The load should be switched OFF prior to connection.

The UPS utilizes a transformer to provide excellent isolation and voltage regulation. During normal operation, the UPS will be warm to the touch, but not hot enough to burn. The transformers have been coated with a laquer finish which may produce a slight, nontoxic odor during the first several weeks of operation.



WARNING

The UPS generates EMR (Electromagnetic Radiation). Keep all sensitive magnetic media, such as credit cards, floppy disks, magnetic key cards, recording tape, etc., away from this unit.

3.2.1 Terminal Block Input and Output

CAUTION: Installation and wiring should be performed by qualified service personnel in accordance with applicable electrical codes. Verify that the main utility panel is switched OFF before proceeding. Mark all circuit breakers supplying the UPS.

1. Connect the input and output wires (Refer to the table below for recommended wire sizes and tightening torques.)

MODEL	TERMINAL BLOCKS		TIGHTENING TORQUE	
	AWG	mm ²	Inch Pounds	Newton Meters
1500-2500 (60Hz)	14	2.0	35	4.0
3000 (60Hz)	12	3.0	35	4.0
2000-3000 (50Hz)	16	1.5	35	4.0

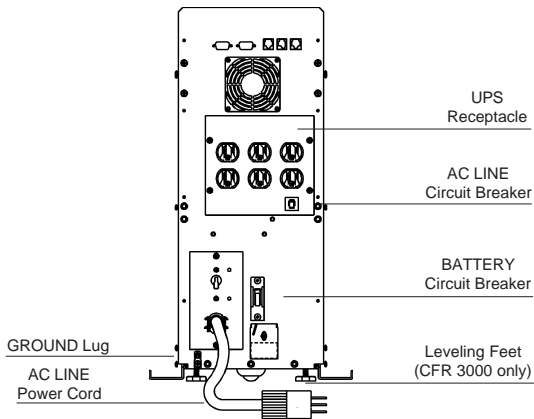

Fig. 10

CFR 1500, CFR 2000, CFR 2500,
and CFR 3000 Rear Panels

3. INSTALLATION

3.2.1 Terminal Block Input and Output Wiring

CFR 1500, CFR 2000, CFR 2500 and CFR 3000 Terminal Block Input

Frequency	Voltage*	L	N
60Hz	120VAC	120VAC	Neutral
50Hz	230VAC	230VAC	Neutral
60Hz	208VAC	Ø1	Ø2
60Hz	240VAC	Ø1	Ø2



WARNING: Overcurrent protection for the AC output circuit must be at the time of installation

CFR 1500, CFR 2000, CFR 2500 and CFR 3000 Terminal Block output

Frequency	Voltages*	L1	N	L2**
60Hz	120 / 208 VAC	120VAC	Neutral	208VAC
60Hz	120 / 240 VAC	120VAC	Neutral	240VAC
50Hz	230VAC	Not Used	Neutral	230VAC



* **CAUTION:** Refer to the nameplate voltage and frequency ratings affixed to the unit. This power supply was wired for this particular voltage configuration when it was shipped from the factory.

**Units shipped as 60Hz, single 120V output, do not use L2.

3.3 External Battery Pack

The CFR is designed so that battery backup time can be greatly extended simply by plugging the EBP 48 External Battery Pack to the back of the UPS. Battery packs are completely self-contained.

Unit	Rating	Run Time* for CFR Module			
		1500	2000	2500	3000
EBP 48A	33 Ah	1.5hrs	1.0hrs	.75hrs	1.1hrs
EBP 48E	88 Ah	3.5hrs	2.4hrs	1.8hrs	2.2hrs

*Battery run times are calculated at typical load (80%) and represent the total time of the CFR internal batteries and EBP battery pack.

1. Switch the CFR's BATTERY circuit breaker OFF.
2. Locate the EXTERNAL battery connector on the rear panel of the UPS and remove the Phillips screw #1 and loosen Phillips screw #2.
3. Slide the cover plate to the left and insert the battery pack's connector into the UPS. Secure the connector to the UPS using the Phillips screw #1.
4. Switch the EBP and CFR "BATTERY" breakers ON and test the unit for proper operation.

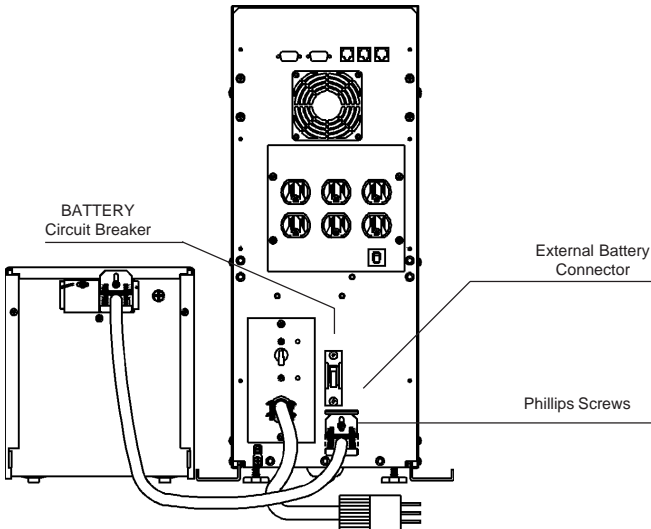

Fig. 11
CFR 1500, CFR2000, CFR 2500, and CFR 3000 with EBP External Battery Packs

3. INSTALLATION

3.4 208 VAC vs 240 VAC (60 Hz) Configurations

In North America, there are only two recognized supply voltages: 208 VAC (most commonly used in industrial, commercial, and office areas); and 240 VAC (most commonly used in residential areas). 120 VAC can be derived from both 208 and 240 VAC services.



NOTE: The terms 220 VAC and 230 VAC are actually local terminology, referring to 240 VAC service.



IMPORTANT:

This unit complies with NEC/CEC for center tapped neutral bond to ground.

VOLTAGE POTENTIAL

UPS units equipped for 208 VAC output operation have a 208 VAC potential *between* L1 and L2. In comparison, when the UPS is wired for 240 VAC output, a 120 VAC potential appears *between* L2 and Neutral, and L1 and Neutral. For further information, contact Alpha for assistance.



The transformer used in the CFR UPS is equipped with an additional tap (L1 to N) for 120 VAC operation. This provides a dual output voltage potential of 208 VAC and 120 VAC. Note: In this configuration, the voltage potential between L2 (208 VAC) and Neutral is only 88 VAC. Refer to the illustration below.

LOAD SHARING

If several pieces of equipment are connected to the 120 V output of the CFR (either to the output receptacle or terminal block), care must be taken to ensure that the total power drawn does not exceed the maximum rating of the unit. For Terminal block output, wherever possible, connect all 120V loads to L1 (**not L2**). If 120 V loads are connected to L2, do not exceed the current listed in Table 3.4.1.

Model	Maximum current on L2
CFR 1500	7.2A
CFR 2000	9.6A
CFR 2500	12.0A
CFR 3000	15.0A

Table 3.4.1

3.4 208 VAC vs 240 VAC (60 Hz) Configurations

Since loads are shared, it is possible to exceed the rated maximum output current of one of the transformer windings, without actually exceeding the rated output current of the CFR-UPS. Therefore, careful consideration must be given as to how the loads connected to the CFR are to be divided.

One way to ensure that the current drawn from each half of the transformer windings is within the CFR's specifications would be to measure the actual total load being drawn. This can be accomplished using a clip-on current probe (refer to the following drawings). The total current being drawn by L1 is a combination of the current draw from A + B + C, (where A is the total current draw from each 120V load connected to the receptacle, B is the total current draw from each 240V load connected to the receptacle, and C is the total current draw from the L1 side of the terminal block). The total of these currents must not exceed the rated output current for each winding of the CFR. The same is true for the L2 winding of the transformer. You can measure these currents at points B and D, (where B is the total current draw from each 240V load connected to the receptacle, and D is the total current draw from the L2 side of the terminal block).



NOTE: If using the SID or IID to measure the output currents, you must calculate the Output current for L1 as described below.

If the CFR has a *SID* installed, the current can be measured via the RS232 port of the CFR connected to a PC, as OUTPUT CURRENT 1 and OUTPUT CURRENT 2 (see section 5.6, Output Parameters). The current drawn in Winding 2 is Output Current 2. **The current drawn in Winding 1 (Output current L1) is calculated by adding OUTPUT CURRENT 1 and OUTPUT CURRENT 2.** The "Overload" light will flash if the current in either winding is exceeded or, if the total output VA or Watts exceeds the maximum rating of the UPS.

If the CFR has an *IID* installed, you can use the menu to display OUTPUT CURRENT 1 and OUTPUT CURRENT 2. **The current in Winding 1 is calculated by adding OUTPUT CURRENT 1 and OUTPUT CURRENT 2.**

3. INSTALLATION

3.4 208 VAC vs 240 VAC (60 Hz) Configurations, *cont'd.*

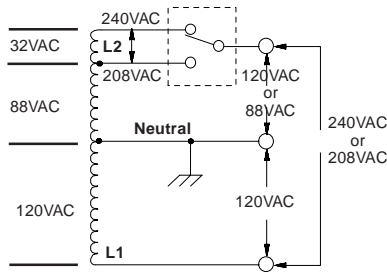

Fig. 12
208 VAC Output Schematic (for reference only)

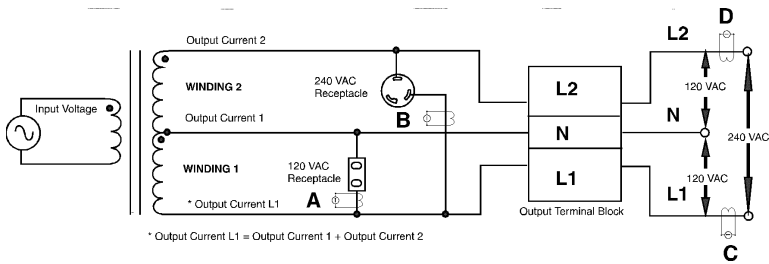

Fig. 13
120/120/240 VAC Power distribution through L1 and L2

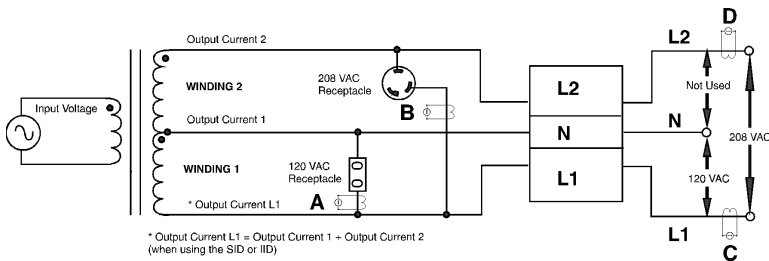

Fig. 14
208/120 VAC Power distribution through L1 and L2

4.1 Start-up and Test

1. Plug the CFR's AC line cord into a wall receptacle or turn the AC Input circuit breaker ON. The TEST LED and OUTPUT LOAD display LEDs will flash for a few seconds to indicate the CFR is powering up. The LINE PRESENT LED will then come ON to indicate the AC input line is OK and the CFR is running on AC line power.
2. Switch the rear panel BATTERY circuit breaker ON to activate the battery circuit.
3. Test the UPS by unplugging the AC line cord from the wall receptacle or turn the AC Circuit Breaker OFF. The front panel amber "LINE FAILURE" LED will light as the UPS initiates LINE FAILURE operation.
4. Plug the AC LINE cord back into the wall receptacle or turn the AC circuit breaker ON. The "LINE PRESENT" LED will come ON to indicate the presence of AC line power. Within 20 seconds, the "LINE FAILURE" LED will shut OFF to indicate that the UPS has resumed LINE PRESENT operation.
5. Once the UPS has been tested, switch the load ON, one piece of equipment at a time, and observe the front panel "OUTPUT LOAD" display. As each additional piece of equipment is switched ON, the LEDs will display the increased load up to 100%. If the "OVERLOAD" LED lights, decrease the load by switching equipment OFF, one unit at a time, until the "OVERLOAD" LED goes OFF.



WARNING: DO NOT RUN THE UPS IN AN OVERLOADED CONDITION.

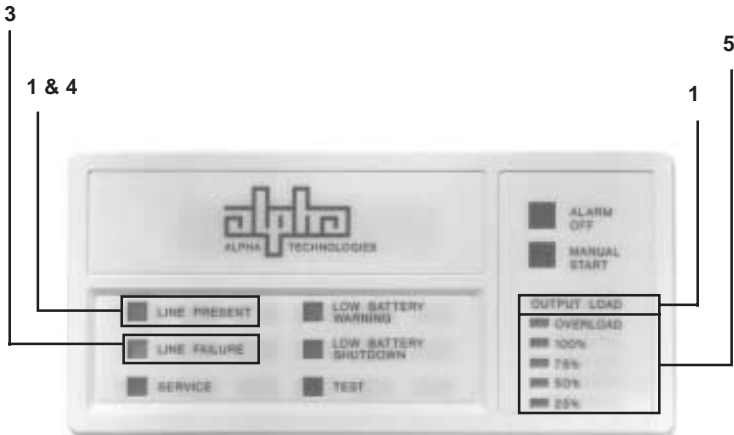

Fig. 15
Standard Interface Device showing start-up LEDs

4. OPERATION

4.1 Start-up and Test

Manual Self-test

Press (and hold for several seconds) the “MANUAL START” switch, located on the Standard Interface Panel, when the UPS is running on AC line power (“LINE PRESENT” LED ON). The unit will test the backup capabilities of the UPS for approximately one minute (“TEST” LED ON). Both the “LINE PRESENT” and “LINE FAILURE” LEDs will be ON. If a problem is detected, the UPS will resume LINE PRESENT operation, without interruption to the output, and light the “SERVICE” LED.

Audible Alarm OFF

Press the “ALARM OFF” switch, located on the Standard Interface Panel, to cancel the audible alarm which may activate when first starting the UPS. The alarm, along with the front panel “LOW BATTERY WARNING” LED, indicates that the UPS batteries are low. The batteries will recharge within several hours of operation.

Manual Start (No AC line power)

Press the “Manual Start” switch to start the UPS from battery power. The UPS will start even though AC line power is not available (“LINE PRESENT” LED OFF).

4.1 Start-up and Test, *continued*

Switching OFF the UPS:

1. Switch all equipment connected to the UPS OFF.
2. Switch the rear panel "BATTERY" circuit breaker OFF. This will prevent the UPS from initiating LINE FAILURE operation when AC power is removed.
3. Unplug the CFR's AC power cord from the wall receptacle.

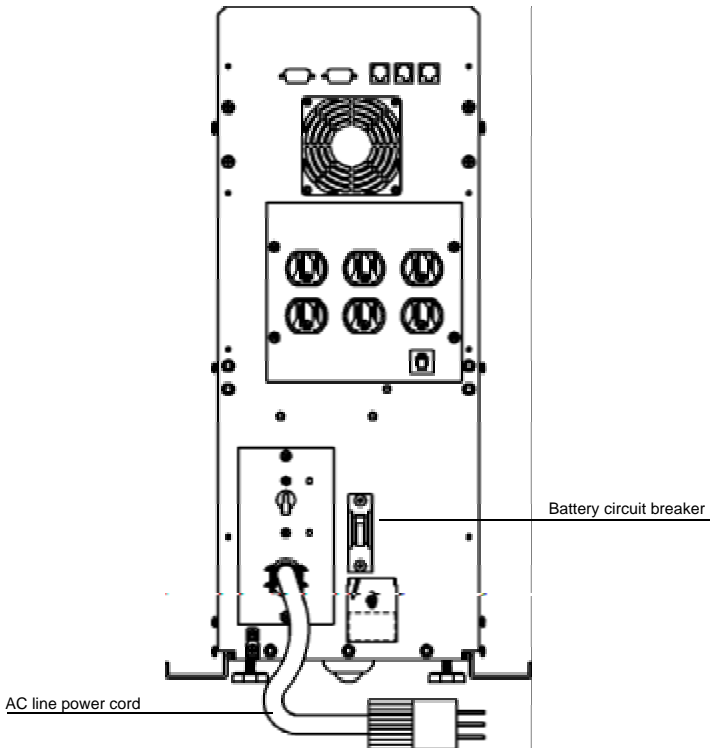

Fig. 16
UPS Shutdown

4. OPERATION

4.2 Using the Standard Interface Device

The Standard Interface Device displays vital UPS operating parameters and has the ability to self-test the UPS at the touch of a button. When used in conjunction with the CFR's rear-panel "Form-C" contact closures, UPS status information can be sent directly to a Local Area Network (see section 2.5).

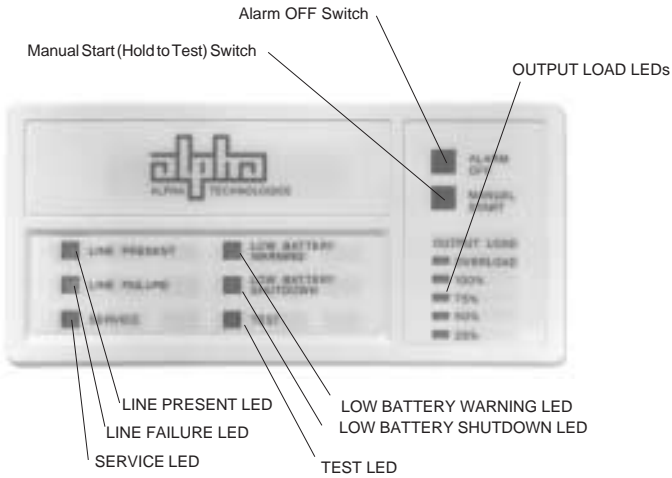

Fig. 17
Standard Interface Device

4.2 Using the Standard Interface Device

UPS Powering Up

Whenever the CFR is powering up, the TEST LED flashes for a few seconds. At the same time the OUTPUT LOAD indicator LEDs flash in a chasing pattern to indicate that there is no output. As soon as the power up sequence is completed, the TEST LED switches OFF and the OUTPUT LOAD display LEDs show the percentage of the load.

Output Shutdown Pending

The TEST LED will flash to indicate that a UPS output shutdown is pending to occur. When the operator gives an output shutdown command (either via the RS-232 serial port or by the LAN Interface port), the UPS delays the shutdown (for a programmable period) before actually switching off the output.

Output Shutdown In Progress

The five OUTPUT LOAD LEDs will flash in a chasing pattern whenever the CFR output is switched off by an output shutdown command (either via the RS-232 serial port or by the LAN Interface port). This will also occur when the unit is first powering up.

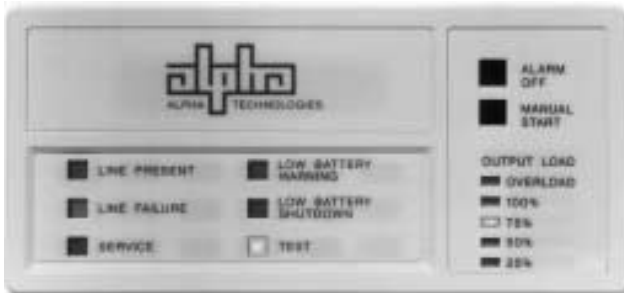

Fig. 18
Test LED and Output Load LED Indicators

4. OPERATION

4.2 Using the Standard Interface Device, *continued*

Line Present Operation

The green "LINE PRESENT" LED indicates that the UPS is running on AC line (utility / mains) power.

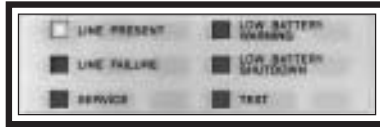

Fig.19

Line Failure (AC Input Out of Tolerance)

Whenever AC line voltage becomes unacceptably high or low (+10 % / 25%), or the line frequency exceeds $\pm 3\%$, the "LINE PRESENT" LED flashes and the "LINE FAILURE" LED lights indicating the UPS is running on backup power.



NOTE: High generator THD can also cause this condition.

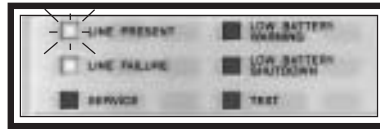

Fig.20

Line Failure Operation

Whenever a utility power outage occurs, the UPS initiates LINE FAILURE operation without interruption of output power. The amber "LINE FAILURE" LED lights to indicate that the UPS is running on backup power.

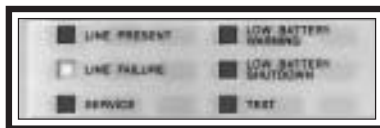

Fig. 21

Line Synchronization

When both the "LINE POWER" and "LINE FAILURE" LEDs are ON, the UPS is synchronizing its output frequency to the utility input prior to resuming AC line operation. Synchronization takes approximately 15 seconds. If the line frequency (generator frequency) is out of tolerance, the UPS can not synchronize to it, and stays in the inverter mode.

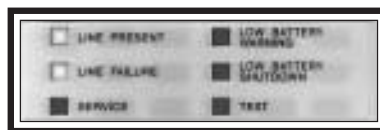

Fig.22

4.2 Using the Standard Interface Device, *continued*

Low Battery Warning

The red “LOW BATTERY WARNING” LED precedes “LOW BATTERY SHUT-DOWN” by 2 to 5 minutes and indicates that the batteries can no longer support the load. Immediate steps should be taken to begin an orderly system shutdown. From LOW BATTERY WARNING, it may take several hours to fully recharge the batteries.

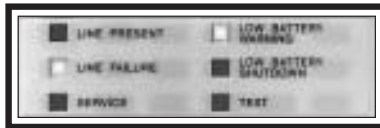

Fig. 23

Low Battery Shutdown

The “LOW BATTERY SHUTDOWN” LED indicates that the UPS has shut itself down to prevent over-discharge damage to the batteries. In critical applications, an additional power source (such as a generator) should be used until utility line power returns.

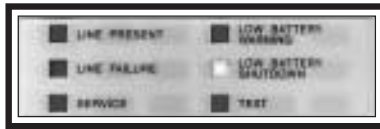

Fig. 24

Test

The yellow “TEST” LED indicates that the UPS is simulating a LINE FAILURE to self-test the backup capabilities of the unit. If, during the one minute test, the UPS fails to supply backup power, it resumes LINE PRESENT operation without interruption to the load and lights the “SERVICE” LED.

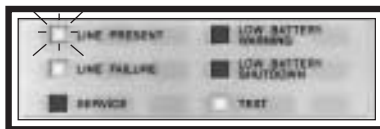

Fig. 25

Service

The “SERVICE” LED indicates that the UPS is no longer able to provide backup power to the load and that service is required. Consult the manual’s troubleshooting section or contact your authorized Alpha service center.

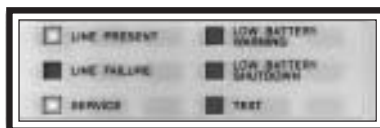

Fig. 26

4. OPERATION

4.2 Using the Standard Interface Device, *continued*

Alarm Off Switch

The switch cancels the audible LOW BATTERY WARNING alarm. The alarm remains disabled until line power is restored and the batteries are recharged.

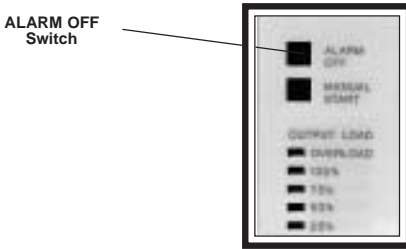

Fig. 27

Manual Start / (old to Test) Switch

The switch is used to start the UPS from battery power whenever AC line power is not available ("LINE PRESENT" LED OFF). The switch can also be used to test the UPS' backup capabilities ("LINE PRESENT" LED ON) without interruption to the load.

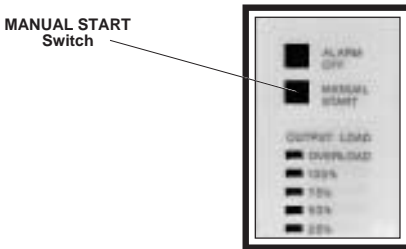

Fig. 28

Output Load Display

The green "25%, 50%, 75%, and 100%" LEDs indicate the loading on the UPS. Whenever the output load exceeds the rated output of the UPS, the red "OVERLOAD" LED lights.



NOTE: Each successive LED lights depending upon the load. If the UPS has a 75% load (displayed), then the 25%, 50% and 75% LEDs will light. DO NOT EXCEED THE OUTPUT RATING OF THE UPS.

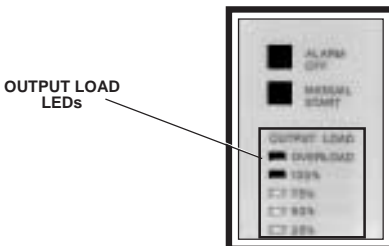

Fig. 29

5.1 Remote RS-232 Operation

Introduction:

This section of the manual describes how to monitor, control and calibrate the CFR-UPS using RS-232 ASCII commands and how to navigate through the program using the menu structure.

The RS-232 serial interface is designed to work with terminal emulation software in an interactive mode. Various parameters and commands may be accessed either through the menus or by typing the number associated with the desired functions. See section 5.3.

RS-232 menus have a hierarchical format. The top level menu, which is also called the OPENING MENU, can be accessed by pressing the ENTER key (which sends a carriage return character). This menu lists the numbers for accessing other sub-menus plus displays the current LINE status and pending ALARM conditions.

The figure below shows the typical opening menu screen which displays the menu options 1 through 7 followed by status and alarm messages. The INPUT LINE shows the current status of the AC line which may be PRESENT; FAILURE; or TEST MODE. The ALARMS message lists all current alarms. For a complete description of alarms refer to section 5.12.

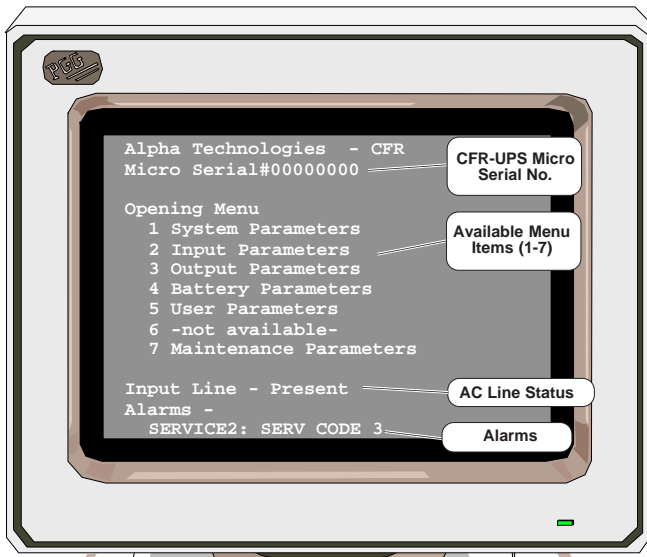

Fig. 30
Opening Menu

To display the System Parameters screen, type "1" and press ENTER.

5. RS-232 TERMINAL COMMUNICATION

5.2 RS-232 Menu Selection Icons

Icons have been placed throughout this section to easily guide you to key commands using remote terminal emulation. The icons provide short cuts to desired display screens without having to step through various menus. To use the icons, simply enter the number contained in the icon screen while you are in the terminal emulation mode. A dark screen icon with white numbers accesses one of the 7 main menus. A light screen icon with black numbers directly accesses the chosen sub-menu function.



The dark screen icon with white lettering accesses one of the main menus. In this example, the #5 (USER PARAMETERS) will appear.



The light screen icon with black lettering directly accesses a sub-menu. In this example, the #55 (SET TEST FREQUENCY) will appear.



This function is not independently selectable as a sub-menu item. It is included as part of the USER PARAMETERS main screen selection.

Fig. 31
PC Communication Icons (used in this manual)

5.3 Remote Terminal Quick Reference

The menu items outlined in this manual can be accessed from a remote terminal. The numbers contained in this guide act as a quick reference to accessing menu functions. Single-digit numbers relate to specific main menus. Double-digit numbers relate to specific sub-menus.

- 0 **QUERY ALL PARAMETERS**

- 1 **SYSTEM PARAMETERS**
 - BATTERY TEMPERATURE
 - 11 START TEST Mode
 - 12 STOP TEST Mode

- 2 **INPUT PARAMETERS**
 - VOLTAGE
 - CURRENT
 - VOLT AMPS
 - POWER IN WATTS
 - POWER FACTOR
 - LINE FREQUENCY

- 3 **OUTPUT PARAMETERS**
 - OUTPUT #1
 - VOLTAGE
 - CURRENT
 - OUTPUT #2
 - VOLTAGE
 - CURRENT
 - VOLT AMPS
 - POWER IN WATTS
 - POWER FACTOR
 - LINE FREQUENCY

- 4 **BATTERY PARAMETERS**
 - VOLTAGE
 - CURRENT
 - CHARGER STATUS
 - TEMPERATURE

- 5 **USER PARAMETERS**
 - SET TEST SCHEDULE
 - 53 SET TEST START
 - 55 SET TEST FREQUENCY
 - 56 TRANSMIT UNSOLICITED ALARMS
 - 58 SET USER SECURITY CODE
 - 59 SET MAINTENANCE SECURITY CODE
 - CFR SOFTWARE VER.
 - MICRO BOARD SER. NO.
 - EEPROM VERSION NO.
 - POWER BOARD SER. NO.
 - 501 START SHUTDOWN WHEN DELAY IS SET
 - 502 START OUTPUT SHUTDOWN
 - 503 CANCEL OUTPUT SHUTDOWN
 - 504 RECOVER OUTPUT SHUTDOWN ONLY WHEN AC LINE RESTORED
 - 505 SET OUTPUT SHUTDOWN DELAY
 - 506 SET OUTPUT SHUTDOWN DURATION
 - 507 SHUT OFF INVERTER - SAVE BATTERY
 - 508 START UP INVERTER FROM SAVE BATTERY
 - 509 NONE
 - 510 TRANSMIT IPC-XXX TYPE UNSOLICITED ALARMS
 - 511 INVERTER ON ALARM DELAY

- 6 - not available -

- 7 **MAINTENANCE PARAMETERS**
 - 70 FAST DETECT LOW REF
 - 71 FAST DETECT HIGH REF
 - 72 MEDIUM DETECT LOW REF
 - 73 MEDIUM DETECT HIGH REF
 - 74 SLOW DETECT LOW REF
 - 75 SLOW DETECT HIGH REF
 - 76 SLOW DETECT HYS. LO REF
 - 77 SLOW DETECT HYS. HI REF
 - 78 MAX. PLL SLEW RATE
 - 79 BATTERY WARNING REF.

5. RS-232 TERMINAL COMMUNICATION

5.4 Menu Commands Overview

Overview

The following section provides a general overview of the menu structure and gives some examples of how to perform certain command functions such as testing the UPS.

Querying CFR Status and Measured Parameters

The current status (mode of operation) of the CFR and all active alarms are displayed at the end of the opening menu (see section 5.12 for a list of status messages and alarm events). Press "ENTER" to query the CFR status and alarms. Use commands "1" to "4" to query the battery temperature, input (line) parameters, output (load) parameters, and battery parameters. Command "0" is a special command which displays all of the UPS parameters together. This command is discussed in section 5.11.

Testing the CFR

Use commands "11" and "12" to start and terminate a self-test. During a self-test, the UPS switches to the inverter mode to test the battery and the inverter hardware. The test takes about one minute and, when complete, an ASCII message is sent to indicate the result. You may also schedule a self-test using commands "53" to "55".

Shutting OFF the Inverter to Save the Battery

Commands "507" and "508" can be used when the UPS is in the inverter mode to switch the inverter OFF to prevent a deep battery discharge during extended line failures. The UPS-CFR switches to normal operation when input line is restored.



NOTE: Invoking the "507" or "508" command will drop the connected load.

Scheduling Output Shutdown/Reboot

The output of the UPS can be turned OFF by sending a RS-232 command. Commands "501" to "506" control the output shutdown feature. When the UPS receives a start shutdown command, "502," it waits for the period specified in **output shutdown delay**, "505," and then turns OFF the UPS output. The UPS remains in the shutdown mode for the mandatory down time specified by **output shutdown duration**, "506." Depending upon the setting of the **output shutdown recovery mode**, "504," the output is switched ON when the shutdown duration expires or when the input is restored. You start a shutdown whenever the shutdown delay is set using command "501." A pending shutdown may be cancelled by sending command "503."

5.4 Menu Commands Overview, *continued*

Calibrating the CFR

The CFR-UPS may be calibrated using two sets of parameters - Maintenance Parameters (commands "70" to "79") and Service Parameters (commands "80" to "89"). Maintenance parameters allow you to customize the CFR detection and warning levels. There should be no need to change these setting unless wider or narrower detection tolerances are required.

Transmitting Unsolicited Alarms

The UPS can automatically transmit alarm messages (in ASCII format) to notify a status change or a power problem as it occurs. You can enable or disable this option by using commands "510" and "509" respectively.

5.5 System Parameters

The "SYSTEM PARAMETERS" screen provides UPS battery temperature information and manual initiation and termination of SELF TEST.



Battery Temperature

Displayed in degrees C, Ambient Temperature is measured inside the in the vicinity of the battery compartment.



Start Test

Self Test can be initiated by selecting this menu. The test duration default is 60 seconds.



Stop Test

Self Test can be terminated prior to the full duration of the test run time.

5. RS-232 TERMINAL COMMUNICATION

5.6 Input Parameters



"INPUT PARAMETERS" provides UPS Input Voltage, Current, Volt Amps, Power in Watts, Power Factor, and Line Frequency information.

Voltage

The voltage measured at the input of the UPS (i.e., 120 VAC).

Current

The flow of current measured at the input of the UPS (i.e., 3.1 Amps).

Volt Amps

The apparent input power of the UPS as calculated by multiplying the input voltage by the input current (i.e., 663 VA).

Power in Watts

The true input power of the UPS as calculated in Watts (i.e., 600 Watts).

Power Factor

The ratio of true power (power actually consumed) to apparent power (simple product of voltage and current) at the input of the UPS (i.e., 0.89).

Line Frequency

The frequency of the AC Line measured at the input of the UPS (i.e., 60 HZ).

5.7 Output Parameters



"OUTPUT PARAMETERS" provides UPS Output Voltage, Current, Volt Amps, Power in Watts, Power Factor, and Line Frequency information.



NOTE: UPS's with dual output voltages offer the option of selecting and viewing the VOLTAGE and CURRENT of each output individually.

Voltage

Output Voltage #1 displays the true RMS voltage for the 120 VAC side (i.e., all 120 volt receptacles) and the voltage between L1 and N on the output terminal block.

Output Voltage #2 displays the true RMS voltage for the 208 VAC or 240 VAC (i.e., all 208 VC or 240 VAC output receptacles) and the voltage between L1 and L2 on the output terminal block. Note: The voltage between N and L2 can be calculated by subtracting Output Voltage #1 from Output Voltage #2.

5.7 Output Parameters, *continued*

Current

Output Current #1 displays the true RMS current on N. If there are no 120 V loads connected to N-L2, then this current represents the 120 V loads on N-L1 plus any equipment connected to the 120 V output receptacles.

Output Current #2 displays the true RMS current on L2. This includes the current flowing in L2 of the output terminal block, plus the current flowing in all 208 VAC or 240 VAC receptacles.



NOTE: The total RMS current displayed for L1 and L2 may be different than the sum of the individual currents flowing in each output receptacle and terminal block. This is because of potentially nonlinear loads which have currents that are not inphase with each other.

Volt Amps

The apparent output power of the UPS is calculated by multiplying the output voltage by the output current. The total UPS output VA may not equal the sum VA drawn from the connected equipment. This is due to different power factor rating for each piece of equipment.

Power in Watts

The real output power of the UPS is calculated in Watts. This will be equal to the sum of the real output power for all equipment connected to the UPS.

Power Factor

This expression refers to the ratio of true power (power actually consumed) to apparent power (simple product of voltage and current) at the output of the UPS.

Line Frequency

This term refers to the frequency (in Hertz) of the AC Line as measured at the output of the UPS.

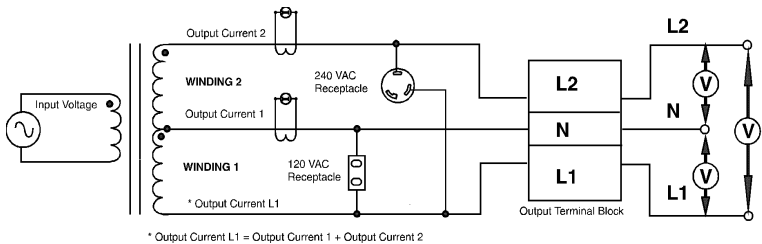

Fig. 32
Output Parameter Measurement Points

5. RS-232 TERMINAL COMMUNICATION

5.8 Battery Parameters



"BATTERY PARAMETERS" provides UPS Battery Voltage, Charger Current, and Charger Status information.

Voltage

Voltage indicates the average DC voltage of UPS batteries. When the UPS is running in "LINE PRESENT" mode and the batteries are charged, the voltage will be approximately 27.6 VDC (equal to the charger's "FLOAT" charge). When the UPS is running in "LINE FAILURE" mode, the battery voltage will slowly decrease until the Battery Low Voltage Cutout is reached (approximately 21.0 VDC). Once utility power is restored, after a prolonged power outage, the battery voltage will slowly climb until the batteries are recharged.



NOTE: If external batteries are connected, their voltage will be reflected as well.

Battery Current

When the UPS is running in "LINE PRESENT" mode, the average DC charger current is displayed (i.e., 2.1 Amps). When the UPS is running in "INVERTER" mode the battery charge current is zero (0).

Charger Status

When the UPS is in "LINE PRESENT" mode, the charger keeps the batteries charged, indicated by "CHARGER STATUS ON". When the UPS is in "LINE FAILURE" mode and running on the batteries, the charger immediately switches OFF, indicated by the display "CHARGER STATUS OFF". Once utility power returns, or an alternative power source (generator) is connected, the charger will switch ON and the DC current will slowly rise after an initial 3 second "soft start" delay.

5.9 User Parameters



"USER PARAMETERS" allows you to set the information for automatic test, output voltage shutdown, display unit identification, and to change the security codes. Whenever one of the USER PARAMETER items is accessed, you are prompted for a security code.



NOTE: The code (1111) is preset at the factory and can be changed by entering the SET USER SECURITY CODE screen (menu item 58).

Unsolicited Alarm Messages

The CFR can transmit alarm messages (in ASCII format) to notify a status change or a power problem. Once this feature is enabled, alarm messages are transmitted automatically on the RS-232 port as soon as the status of the CFR changes. You can connect a terminal to the CFR to monitor its status and log all power problems. Refer to menu items 56 and 509-511 for a detailed description.

Automatic Output Shutdown

The output of the CFR can be turned off by sending a command via the RS-232 port using a computer or terminal. Refer to menu items 501-508 for a detailed description (menu items 501-506 are intended for scheduled shutdown even when the AC line is present; 507 and 508 items can be used to switch the inverter ON and OFF to preserve the battery).

5.9 User Parameters, *continued*

When the CFR receives a “Start Shutdown” command (menu item 502), it waits for the period that is specified in the “Output Shutdown Delay” (menu item 505) and then shuts down its output. The CFR will remain in the shutdown mode for the time specified in the “Output Shutdown Duration” (menu item 506). Depending upon the setting of the “Output Shutdown Recovery Mode” (menu item 504) the CFR may restore output power immediately, even if the input AC line is not present, or may wait for the input AC line to be restored.



Set Test Schedule

The UPS can be setup to perform a routine self-test at intervals you specify. This will place the UPS into “LINE FAILURE” mode at a specific time in order to test its functionality and the capacity of the batteries.



Set Test Start (DD:HH:MM = dd:hh:mm)

dd = Days
hh = Hours
mm = Minutes

(i.e., “05:02:15” represents start test in 5 days, 2 hours, 15 minutes). If the dd, hh and mm are set to 00 then the automatic self-test is inactive. After each self-test the start time is reset to the number of days specified in the “Set Test Frequency” (menu item 55). This feature requires the USER SECURITY CODE for activation.

This menu is utilized to set the self test schedule by setting the count down duration for the start of test. For example, if the user wishes to set the start of test at midnight and the current time is 6:00 PM, the user can enter the start of test frequency to (00:06:00) which represents 6 hours. **(NOTE: In the absence of an IID, the CFR does not have a real time clock on board, and therefore the timing function may drift slightly over a period).** The self-test takes 1 minute to complete.



Set Test Frequency (XXX)

xxx = “off” or “dd days” - dd represents days

The user can activate the auto self-test feature by setting the test frequency to every “dd” days. The self-test will start at the value displayed in the “Set Test Start” line in “DD:HH:MM” format.

“OFF” indicates that the automatic self-test function is disabled. It can be set by entering 0 days for Test Frequency. “dd days” indicates that the automatic self-test function is enabled and is set to run the self-test at the interval entered in this field. The maximum value is 30 days; default is “OFF”. This feature requires the USER SECURITY CODE for activation.



NOTE: If the SID is installed, the TEST LED flashes while the test is in progress.



Transmit Unsolicited Alarms

This command displays the current settings of the unsolicited alarms feature. The following text is displayed when this menu is accessed.

56 Transmit Unsolicited Alarms
509 None (xxxx)
510 IPC-XXX (xxxx)
511 Inverter On Alarm Delay (xxxx)

5. RS-232 TERMINAL COMMUNICATION

5.9 User Parameters, *continued*



Set User Security Code

The security code is used to restrict entry into certain areas of the program. The code (1111) is preset at the factory and allows access to USER PARAMETERS and HISTORY programs. The security code can be changed using the number keys on the keypad. **CAUTION:** *If the security code is changed and no record is kept, especially if the code becomes forgotten or lost, you will not be able to reenter the program.*



Display Unit Ident.

This screen is used to display vital information pertaining to the Intelligent Interface Device, the micro-controller board and the CFR's power board. This information is extremely useful for troubleshooting and maintenance.

Display Micro Ident.

Displays the software version and serial # of the micro-controller board.

Display PwrBd. Ident.

Displays the EE Prom # and serial # of the CFR's power board.



Set Maintenance Security Code

The Maintenance Security Code is a second level of security and is used to gain access to the maintenance programs. The code can be changed using the number keys on the keypad. **CAUTION:** *If the code is changed and no record is kept, especially if the code becomes forgotten or lost, you will not be able to reenter the program.* The factory default setting is 1111.



Start Shutdown When Delay is Set (xxx)

xxx= "Yes" or "No", (Default value is "No")

This command sets the "Output Shutdown Start Mode". If this option is set to "No", the CFR waits for a shutdown command (menu item 502) to start the shutdown sequence. However, if this option is set to "Yes", the CFR starts a shutdown sequence when the output shutdown delay is set (menu item 505). Changing this option requires the USER SECURITY CODE.



Start Output Shutdown

This command causes the unit to shutdown after the delay period specified in menu item 505 "Set Output Shutdown Delay", and for the mandatory shutdown duration specified in menu item 506 "Set Minimum Output Shutdown Duration". You can use commands 505 and 506 to set the output shutdown delay and duration, and then send this command to shutdown the unit. During the "Output Shutdown Delay" the TEST LED flashes to indicate that a shutdown is pending. When the unit is in the Output Shutdown mode, the five power LEDs will flash, in sequence, to indicate that the UPS is powered-up with no output voltage present. Activating this command requires the User Security Code.

Also displayed on line 502 is the current status of the output:

"off"	No shutdown is scheduled.
"shutting down in hh:mm:ss"	Indicates the time remaining until shutdown.
"shutdown in progress"	No output.

5.9 User Parameters, *continued*



Cancel Output Shutdown

This command cancels any pending or current UPS output shutdown. This command requires the USER SECURITY CODE.



Recover Output Shutdown Only When AC Line Restored (xxx)

xxx="Yes" or "No", (Default value is "Yes")

This command determines when the CFR restores output power after a output shutdown. If this option is set to "Yes", the UPS restores output when the input AC line is restored. Note that the output is guaranteed to be off for the "Output Shutdown Duration" period. During this period, the CFR will not activate the output, even if AC line is restored. However, if this option is set to "No", then the CFR activates its output as soon as the "Output Shutdown Duration" has expired. Thus, the CFR may even restore output in the inverter mode. Changing this option requires the USER SECURITY CODE.



Set Output Shutdown Delay (HH:MM:SS= hh:mm:ss)

This command sets the "output shutdown delay" period. After the CFR receives an output shutdown command, it will wait for this period before switching off the output.

hh:mm:ss - hh is hours; mm is minutes; ss is seconds. Entering the seconds is optional, (i.e., HH:MM format is also acceptable). The factory default setting for this value is 00:00:00 which causes the CFR to immediately shutdown when a shutdown command is set. If the CFR is set to start shutdown when delay is set (menu item 501 is set to "Yes"), then it also acts as a shutdown command, and the count down for shutting down the unit starts immediately (there is no need to issue a 502 command). This feature requires the USER SECURITY CODE for activation.



Set Output Shutdown Duration (HH:MM:SS= hh:mm:ss)

This command sets the "Output Shutdown Duration" which is the guaranteed down time after an output shutdown.

hh:mm:ss - hh is hours; mm is minutes; ss is seconds. Entering the seconds is optional, (i.e. HH:MM format is also acceptable). The factory default setting for this value is 00:00:05 which causes the CFR to remain in shutdown for a minimum of 5 seconds. The CFR may restore output immediately when this duration is expired, or may wait for the AC line to be restored (depending on the setting of menu item 50). This feature requires the USER SECURITY CODE for activation.



Shut Off Inverter / Save Battery

This feature requires the USER SECURITY CODE and can only be activated if unit is in LINE FAILURE mode. The inverter can then be shut off to preserve battery power if its no longer necessary to back up the load. Upon return of the line voltage, the unit will then resume operation as normal.



Start-up Inverter From Save Battery

This feature requires the USER SECURITY CODE and can be activated only if the inverter was shut off from save battery (507). The inverter then can be restarted to provide power to the load.

5.9 User Parameters, *continued*



Disable Transmission of Unsolicited Alarms

"509 None (xxxx)"; xxxx= "active" or blank; default is "active."

Setting this option to "active" disables the transmission of all unsolicited alarm messages. USER SECURITY CODE is required to set this option.



Transmit IPC-XXX Type Unsolicited Alarms

"IPC-XXX (xxxx)"; xxxx= "active" or blank; default is blank

Setting this option to "active" causes unsolicited alarm messages of type IPC-XXX to be transmitted whenever the status of the CFR changes. These are ASCII type messages which are sent on the RS-232 port. The USER SECURITY CODE is required to activate this option.

The following is a list of the unsolicited alarm messages.

- UPS000 - power up
- UPS001 - input out of tolerance
- UPS002 - input blackout
- UPS003 - inverter on
- UPS004 - line mode
- UPS005 - low battery warning
- UPS006 - low battery shutdown
- UPS007 - overload
- UPS008 - load OK
- UPS009 - temperature high
- UPS010 - temperature OK
- UPS011 - service required
- UPS012 - UPS malfunction
- UPS013 - self-test (Inv. on)
- UPS014 - self-test passed (line mode)
- UPS015 - self-test failed



Delay Transmission of Inverter On Unsolicited Alarms

"Inverter on Alarm Delay (xxxxx)"; xxxxx= "off" or "m=min", where m specifies 1 to 5 minutes; default setting is "off".

Transmission of the "inverter on unsolicited message," (*i.e.*, *UPS003 - inverter on*), can be delayed for 1 to 5 minutes to prevent short interruptions in the input AC line from being displayed. Setting this option to "off" causes all AC line interruptions to be displayed. USER SECURITY CODE is required to change this option.

5.10 Maintenance Parameters



"MAINTENANCE PARAMETERS" allow you to customize UPS detection and warning characteristics. Normally, there should be no need to change these factory settings.



CAUTION: If any of these parameters are changed, it is vital to thoroughly test the UPS since an improper adjustment can render the unit useless. Since each parameter is viewed through reference numbers (1 - 16) and translated into a scale of "reasonable" adjustments, an increase or decrease of 2 - 3 reference numbers will have a noticeable affect. If you have questions, contact Alpha prior to making any adjustment.



Fast Detect Lo Ref

Increasing this value will make the UPS more sensitive to a fast, low amplitude line disturbance (glitch).



Fast Detect Hi Ref

Increasing this value will make the UPS more sensitive to a fast, high amplitude line disturbance (spike).



Medium Detect Lo Ref

Increasing this value will make the UPS more sensitive to a slow, low amplitude line disturbance (sag).



Medium Detect Hi Ref

Increasing this value will make the UPS more sensitive to a slow, high amplitude line disturbance (surge).



Slow Detect Lo Ref

Increasing this value will make the UPS more sensitive to a slow, low amplitude line disturbance (brownout) by raising the brownout detection level.



NOTE: The Slow Detect Hys Lo Ref should also be adjusted by the same amount.

5. RS-232 TERMINAL COMMUNICATION

5.10 Maintenance Parameters, *continued*



Slow Detect Hi Ref

Increasing this value will make the UPS more sensitive to a slow, high amplitude line disturbance (sustained overvoltage) by lowering the overvoltage detection level.



NOTE: The Slow Detect Hys Hi Ref should also be adjusted by the same amount.



Slow Detect Hys Lo Ref

Increasing this value will raise the voltage level at which the UPS will *resume* LINE POWER operation after a line disturbance has been corrected. This setting should normally be 1 - 3 settings *above* the Slow Detect Lo Ref setting.



Slow Detect Hys Hi Ref

Increasing this value will lower the voltage level at which the UPS will *resume* LINE POWER operation after an overvoltage condition has been corrected. This setting should normally be the same, or 1 - 3 settings *above*, the Slow Detect Hi Ref setting.



Max. PLL Slew Rate

Increasing this value will reduce the speed at which the Phase Locked Loop (PLL) will change the output frequency while the UPS resumes LINE PRESENT operation after a line fault has been corrected. It will also increase the time required to resume LINE PRESENT operation.



Battery Warning Ref

Increasing this value will increase the time before a LOW BATTERY WARNING occurs, thus allowing the batteries to drain more of their charge before a warning is given. Decreasing this value will allow more run time between LOW BATTERY WARNING and SHUT-DOWN.

5. RS-232 TERMINAL COMMUNICATION

5.12 Event Descriptions (Alarms)

There are 6 alarm groups which upon activation will be displayed at the end of the opening menu. These are:

INPUT:
BATTERY:
OUTPUT:
ENVIRONMENTAL:
SERVICE1:
SERVICE2:

The following lists the mnemonics and description for each alarm group:

INPUT:
FREQ_LO - input line frequency low
FREQ_HI - input line frequency high
GLITCH - input line glitch has been detected
SPIKE - input line spike has been detected
SAG - input line sag has been detected
SURGE - input line surge has been detected
BROWNOUT - input line brownout has been detected
SLOW_SURGE - input line slow surge has been detected
BLACKOUT - input line blackout has been detected

BATTERY:
LO_BAT_SHTDWN - battery voltage shutdown level detected
LO_BAT_WARN - battery voltage low warning level detected
BAT_VOLT_HI - battery over voltage level detected *
FAIL_SELF_TEST - failed self test *
BATT_FLT - battery fault has been detected *

OUTPUT:
VOLT_LO - output voltage low has been detected
VOLT_HI - output voltage high has been detected
PWR_OVLD - output power overload has been detected
VA_OVLD - output VA overload has been detected
OVER_V_FLT - output over voltage fault has been detected *
SHORT_CCT - output short circuit has been detected *

ENVIRONMENTAL:
AMB_TEMP_HI - high internal ambient temperature detected *

SERVICE 1:
SERV CODE 1 - phase lock loop failure has been detected *

SERVICE 2:
SERV CODE 2 - micro software reset has been activated
SERV CODE 3 - micro hardware reset has been activated
SERV CODE 4 - power board EEPROM fault has been detected *
SERV CODE 5 - power board hardware fault has been detected *
SERV CODE 6 - neg DC supply rail has been detected *
EMGNCY POFF - emergency power off has been activated
OUTV SHTDWN - remote shutdown feature is currently active

*(service light alarm)

5.12 Event Descriptions (Alarms), *continued*

Several alarms can be triggered during the same event. If there is a loss of AC line voltage, for example, the UPS may detect a glitch, low frequency and blackout.

Low Battery Warning (LO_BAT_WARN) - The batteries are near the end of their useful charge. If AC line power is not restored within a short period of time, output power will be lost. All systems should be shutdown immediately to prevent loss of data.

Low Battery Shutdown (LO_BAT_SHTDWN) - To prevent an over-discharge condition of the batteries, the unit has shutdown. Output power is terminated in this condition.

Battery Voltage High (BAT_VOLT_HI) - The charging voltage is higher than the threshold setting for the batteries. This could be the result of a defective charger, improper external battery connections, or defective batteries. Service the unit or batteries to correct condition.



NOTE: This condition activates the SERVICE alarm, along with an audible alarm which can be cleared by pressing the ALARM OFF or MUTE key.

Failed Self-Test (FAIL_SELF_TEST) - The unit could not maintain output power while in the self-test mode. Check the batteries and circuit breakers.



NOTE: This condition activates the SERVICE alarm, along with an audible alarm which can be cleared by pressing the ALARM OFF or MUTE key.

Battery Fault (BATT_FLT) - The battery charger is not able to supply the proper amount of current or voltage to the batteries. This condition usually indicates that the batteries are not connected or the BATTERY circuit breaker is switched OFF.

Glitch (GLITCH) - A glitch is a fast, low amplitude line disturbance where the input voltage drops momentarily (less than 8 ms). **

Spike (SPIKE) - A spike is a fast, high amplitude line disturbance where the input voltage rises momentarily (less than 8 ms). **

Sag (SAG) - A sag is a slow, low amplitude line disturbance where the input voltage decreases for 8 - 40 ms. **

Surge (SURGE) - A surge is a slow, high amplitude line disturbance where the input voltage increases for 8 - 40 ms. **

Brownout (BROWNOUT) - A brownout is a slow, low amplitude line disturbance where the input voltage decreases for a long period of time (greater than 16 ms). **

Slow Surge (SLOW_SURGE) - A brownout high (high overvoltage) is a slow, high amplitude line disturbance where the input voltage increases for a long period of time (greater than 16 ms). **

** Indicates events that cause the UPS to operate in "LINE FAILURE" mode.

5. RS-232 TERMINAL COMMUNICATION

5.12 Event Descriptions, *continued*

Blackout (BLACKOUT) - The blackout alarm is triggered when the input voltage is lost for 12 ms, or when the RMS input voltage is less than 1/2 the nominal voltage for 100 ms or longer. * *

Frequency High (FREQ_HI) - A frequency high alarm is triggered when there is a power line problem where the input frequency increases beyond the preset limit. * *

Frequency Low (FREQ_LO) - A frequency low alarm is triggered when there is a power line problem where the input frequency decreases beyond the preset limit. * *

Output Voltage Low (VOLT_LO) - The output voltage low alarm indicates that the output of the UPS is too heavily loaded, or there is a fault within the UPS. Reduce the load connected to the UPS.

Output Voltage High (VOLT_HI) - The output voltage high alarm can be caused by some equipment which draws power at irregular intervals. Disconnect all equipment from the UPS and determine whether the fault will repeat. If it does, the unit may be out of calibration, or there is an internal fault causing the overvoltage condition. Have the unit serviced by an authorized Alpha Repair Depot.

Output Power Overload (PWR_OVLD) - The output power overload alarm indicates a condition where the output of the UPS is too heavily loaded. If this is not corrected, the unit may go into a shutdown condition to protect the UPS's internal circuitry.

Output VA Overload (VA_OVLD) - The output VA overload alarm is triggered when the RMS current exceeds the rating of the UPS. Reduce the load on the output of the UPS to prevent overheating.

Output Over Voltage Fault (OVER_V_FLT) - The output overvoltage fault alarm indicates a malfunction has been detected in the control circuit. The output voltage has been shut off to protect the load from an overvoltage condition.

Output Short Circuit (SHORT_CCT) - The output short circuit alarm indicates a load was connected to the UPS that was shorted. This could be caused by a miswired AC power cord or equipment connected to the UPS that is in need of repair.



NOTE: This condition activates the SERVICE alarm, along with an audible alarm which can be cleared by pressing the MUTE key.

Internal Temperature High (AMB_TEMP_HI) - The internal temperature high alarm indicates that the temperature of the UPS, measured by internal circuitry, was found to be too high. This could be caused by a sustained overload on the output of the UPS, a blocked fan (if equipped), or operating the unit in an excessively high ambient temperature. To prolong the life of the batteries and UPS components, determine and correct the cause of the over-temperature condition.

* * Indicates events that cause the UPS to operate in "LINE FAILURE" mode.

5.12 Event Descriptions, *continued*

Input Line Fail - Indicates that the UPS switched to backup power to protect the equipment for one (or more) of the above conditions. * *

Normal Line Mode - Indicates that the UPS is drawing power from the AC line and charging the batteries.

Test Mode - Indicates the UPS was put into a test mode condition either by the TEST SCHEDULE routine or by pressing the TEST button on the Intelligent Interface Device's panel. The unit will switch to backup power while in the test mode. * *

Float Charge Mode - This is the normal operating mode of the battery charger. During LINE PRESENT operation, the batteries constantly receive a "Float" charge voltage to ensure that backup power is available when required.

Service Codes (1-6) - These codes indicate a potential fault within the UPS. Call Alpha Customer Support and report any displayed Service Codes. Also refer to the Troubleshooting section (6.7) of the manual.

Serv Code 1 - Phase Lock Loop Failure. The phase lock loop circuitry has failed to lock onto the AC input LINE due to instability of the frequency. If the UPS is operating from a generator, check the frequency and adjust it if necessary.

Serv Code 2 - Micro software reset. The internal "watch dog" circuit has detected a fault and reset the software. Contact Alpha to help determine the cause of the fault.

Serv Code 3 - Micro hardware reset. A micro hardware reset is activated as part of the power on condition. If this alarm occurs during normal operation, it may indicate a malfunction in the hardware circuitry. Contact Alpha to help determine the cause of the fault.

Serv Code 4 - Power board EEPROM fault. The EEPROM on the power board contains the unit configuration information. If this fault occurs, it signifies either the configuration information has been corrupted, the EEPROM has malfunctioned, or there is a loose connection inside the UPS.

Serv Code 5 - Power board hardware fault. The control circuitry on the power board has detected a hardware fault condition which impedes correct operation of the UPS.

Serv Code 6 - Neg DC supply rail fail. The negative voltage power supply to the microcontroller has malfunctioned.

EMGNCY POFF - Emergency power shutdown.

OUTV SHTDWN - See menu 505 & 506 (see section 5.9).

* * Indicates events that cause the UPS to operate in "LINE FAILURE" mode.

5. RS-232 TERMINAL COMMUNICATION

5.13 RS-232 Terminal Setup

Terminal Emulation Setup

If you are using a terminal emulation software (such as PROCOMM) to communicate with the CFR, use the following setup:

Emulation Type:	VT100 or compatible
Duplex Mode:	Half Duplex
Xon/Xoff Flow Control:	SID: ON, IID: OFF
RTS/CTS Flow Control:	SID: OFF, IID: ON
Line Wrap:	ON
Screen Scroll:	ON
CR Translation:	CR
Back-Space:	N/A (See NOTE 1)
Break Length:	N/A
Inquiry:	N/A



NOTE: Back-Space and Delete characters are ignored by the CFR. In the event of an incorrectly typed command, you should press Enter and type the command again.

RS-232 Cable Diagrams

The RS-232 port on the CFR follows the Data Communication Equipment (DCE) pinout. To connect this port to a terminal or a host computer (which uses a DTE pinout) you need a standard off-the-shelf (straight through) RS-232 cable. Depending on your computer, you need a “9 to 9 serial cable” or a “9 to 25 serial cable”. However, if you decide to make you own cable, see Figures 6-7. This Figure shows the cable that works with both SID and IID. If your CFR has a SID interface, then you do not have to wire up the RTS and CTS signals.

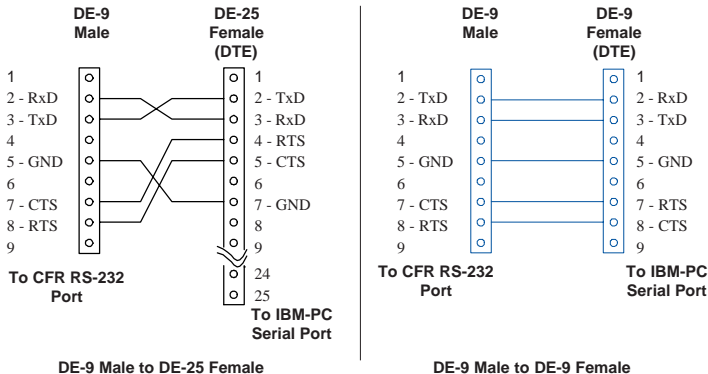

Fig. 33
RS-232 Connector Cable Wiring

6.1 CFR Maintenance

The electronic components used in the UPS require no maintenance. If the unit fails to perform a specific function, refer to the troubleshooting guide. The guide lists typical symptoms, causes and solutions that apply to the UPS, starting with the most obvious and working systematically through the unit.

By establishing a routine maintenance program and following the guidelines contained in this manual, your Alpha CFR will continue to provide years of trouble-free service.

6.2 Battery Maintenance

The maintenance free batteries used in the UPS will be affected by many variables including operating temperatures, number of discharges over the life of the battery, charging characteristics, and low voltage cell cutoff. The Alpha CFR complies with all factory recommendations for charging and discharging batteries to ensure optimum performance and the longest possible battery life.

During normal operation, the UPS batteries will tend to increase in capacity over the first three to twelve months of service. There can be as much as a 20% increase in available backup power after the first ten to fifteen battery discharges. Once the batteries reach this peak, they will slowly begin to lose capacity until, eventually, they will be unable to provide the required backup power.

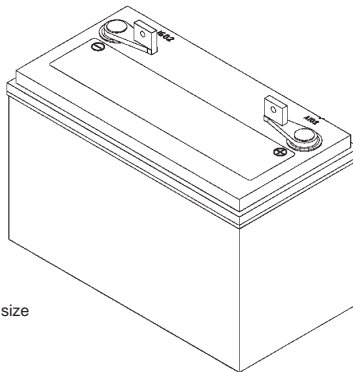

Note: Battery terminals vary in size and shape.

Fig. 34
Typical UPS Battery

6. MAINTENANCE

6.3 Battery Testing



To determine the maximum amount of battery run time available, run this test at least once a year. The length of the test can vary from several minutes to many hours and should not be done during critical applications. Since the test discharges the batteries, backup power may not be readily available (for several hours) in the event of a utility power failure.

1. Unplug the AC line cord from the wall receptacle. The front panel "LINE FAILURE" LED will come ON. Make a note of the START time.
2. When the CFR reaches LOW BATTERY WARNING, record the time. Subtract the START time to determine the actual safe run time. To cancel the test, plug the AC line cord back into the wall receptacle.
3. To determine the reserve time available, allow the UPS to continue until it reaches LOW BATTERY SHUTDOWN. Warning: This will cause the load to go down. Make a note of the time. Subtract the LOW BATTERY WARNING time to determine your available reserve time.
4. Switch the load OFF. Plug the AC line cord back into the wall receptacle. The "LOW BATTERY WARNING" LED will remain ON until the batteries are partially recharged. Switch the load ON, one device at a time. To determine recharge time, subtract the time you resumed LINE PRESENT operation from when the "LOW BATTERY WARNING" LED goes OFF.



Fig. 35 - Standard Interface Device



Fig. 36 - Intelligent Interface Device

6.4 Removing the CFR Front Panel and Cover



CAUTION: INTERNAL MAINTENANCE SHOULD BE SERVICED ONLY BY QUALIFIED PERSONNEL.



1. Disconnect all loads from the OUTPUT receptacles on the UPS.
2. Switch the rear panel BATTERY circuit breaker OFF.
3. Disconnect the UPS from the AC wall receptacle.
4. If an external battery pack is connected to the UPS, remove the connector from the UPS rear panel.
5. Loosen the two (2) Phillips screws from the UPS front panel (located in the lower grill). Carefully pull the lower part of the front panel away from the UPS and lift the panel straight up.
6. Remove the twelve (12) Phillips screws from the sides and rear of the UPS.
7. Carefully lift the cover upward until it clears the chassis.

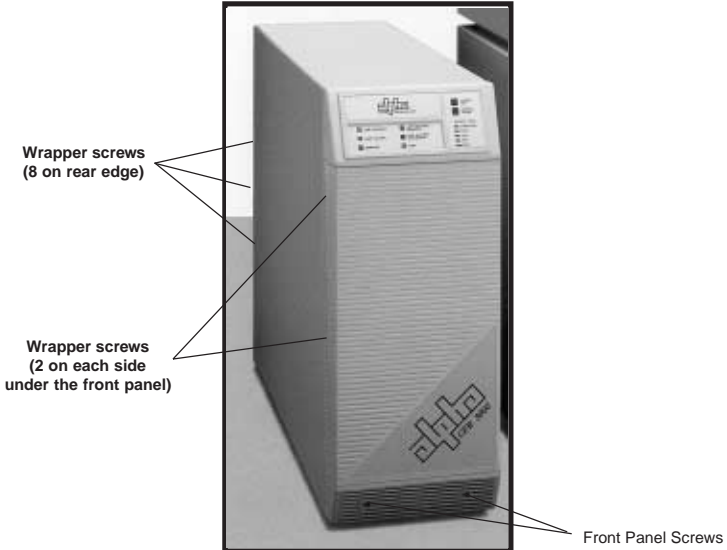
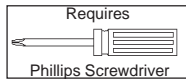

Fig. 37
Front Panel Removal

6. MAINTENANCE

6.5 Internal Battery Replacement



IMPORTANT: Read the safety precautions located at the front of the manual before proceeding.



WARNING: Do not short out battery terminals.

Batteries should be inspected every year for signs of cracking, leaking, or swelling.

Always replace batteries with those of an identical type and rating. Never install old or untested batteries.

Contact Alpha Technologies to order and recycle batteries.

6.5 Internal Battery Replacement, *continued*

CFR 1500, CFR 2000(E), CFR 2500(E) Internal Battery Replacement Procedure.

IMPORTANT: READ THE SAFETY PRECAUTIONS LOCATED AT THE FRONT OF THE MANUAL BEFORE PROCEEDING.



NOTE: All references to left and right are made facing the front of the CFR

1. Remove power from the CFR (Section 4.1)
2. Remove the CFR front panel and cover (Section 6.4)
3. Make a note of the battery orientation and cable connections. Carefully remove the BLUE (negative) wire from the negative (left) terminal of the rear battery.
4. Remove the RED (positive) wire from the positive (left) terminal of the front battery.



NOTE: The BLUE (negative) wire must be disconnected before removing the RED (positive) wire.

5. Remove the RED (jumper) wires from the remaining batteries.
6. Remove the two white foam blocks.
7. Carefully lift and remove the center two batteries from the side of the CFR chassis. Slide the remaining batteries to the middle and remove.



WARNING: Do not let the battery terminals contact the chassis.

8. Place new batteries into the UPS in reverse order of steps 1-7. Test the UPS for proper operation before connection of the load.

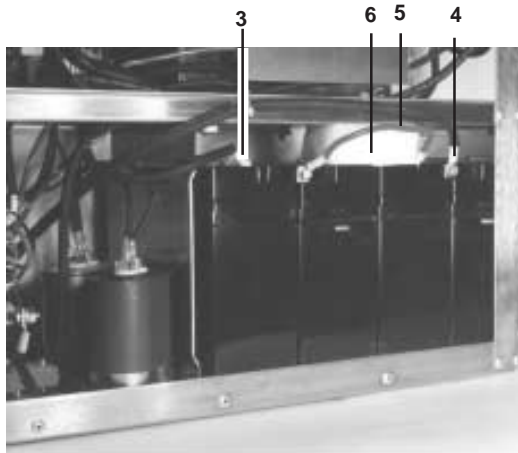

Fig. 38
CFR 1500, 2000, 2500 Battery location

6. MAINTENANCE

6.5 Internal Battery Replacement, *continued*

CFR 3000(E) Internal battery replacement procedure

IMPORTANT: READ THE SAFETY PRECAUTIONS LOCATED AT THE FRONT OF THE MANUAL BEFORE PROCEEDING.



NOTE: All references to left and right are made facing the front of the CFR

1. Remove power from the CFR (Section 4)
2. Remove the CFR front panel and cover (Section 6.4)
3. Make a note of the battery orientation and cable connections. Carefully remove the BLACK (negative) wire from the negative (left) terminal of the rear battery.
4. Remove the RED (positive) wire from the positive (right) terminal of the front battery.



NOTE: The BLACK (negative) wire must be disconnected before removing the RED (positive) wire.

5. Remove the BLACK (jumper) wires from the remaining batteries.
6. Remove the eight white foam blocks.
7. Remove the four bolts holding the right stabilizer and remove the stabilizer.
8. Carefully remove the center two batteries from the side of the CFR chassis. Slide the remaining batteries to the middle and remove.



WARNING: Do not let the battery terminals contact the chassis.

9. Place new batteries into the UPS in reverse order of steps 1-8. Test the UPS for proper operation before connection of the load.

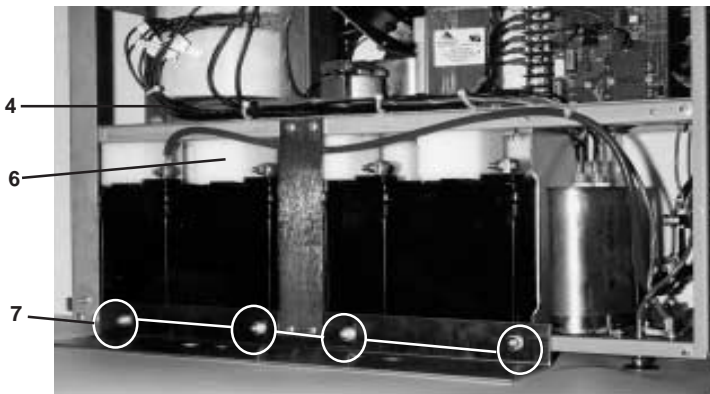

Fig. 39
CFR 3000 Battery location

6.6 Troubleshooting Guide

SYMPTOM	CAUSE	REMEDY
No Output Power: "LINE PRESENT" OFF "LINE FAILURE" OFF	Utility power outage; <i>or</i> AC power cord unplugged; <i>or</i> AC input circuit breaker OFF. <i>and</i> BATTERY circuit breaker OFF.	Plug in AC power cord. Reset breaker. Reset breaker.
Unit does not resume LINE PRESENT operation when power returns: "LINE PRESENT" ON (or flashing) "LINE FAILURE" ON	AC line voltage too high or low; <i>or</i> UPS is in its synchronization mode.	Wait for voltage to stabilize. Wait approximately one minute for synchronization.
"SERVICE" LED ON	BATTERY breaker tripped. <i>or</i> Internal charger fuse open. <i>or</i> Loose or corroded battery cables. <i>or</i> Bad batteries.	Reset breaker. *Replace fuse. *Clean and tighten battery cables. *Replace batteries.
Incorrect output voltage: "LINE PRESENT" ON "LINE FAILURE" OFF "OVERLOAD" ON	Overloaded output; <i>or</i> Shorted output.	Reduce load. Check load for short.

6.6 Troubleshooting Guide

SYMPTOM	CAUSE	REMEDY
No Output Power: "LINE PRESENT" OFF "LINE FAILURE" OFF	Utility power outage; <i>or</i> AC power cord unplugged; <i>or</i> AC input circuit breaker OFF. <i>and</i> BATTERY circuit breaker OFF.	Plug in AC power cord. Reset breaker. Reset breaker.
Unit does not resume LINE PRESENT operation when power returns: "LINE PRESENT" ON (or flashing) "LINE FAILURE" ON	AC line voltage too high or low; <i>or</i> UPS is in its synchronization mode.	Wait for voltage to stabilize. Wait approximately one minute for synchronization.
"SERVICE" LED ON	BATTERY breaker tripped. <i>or</i> Internal charger fuse open. <i>or</i> Loose or corroded battery cables. <i>or</i> Bad batteries.	Reset breaker. *Replace fuse. *Clean and tighten battery cables. *Replace batteries.
Incorrect output voltage: "LINE PRESENT" ON "LINE FAILURE" OFF "OVERLOAD" ON	Overloaded output; <i>or</i> Shorted output.	Reduce load. Check load for short.

6. MAINTENANCE

6.6 Troubleshooting Guide, *continued*

SYMPTOM	CAUSE	REMEDY
No output voltage during utility outage: "LINE PRESENT" OFF "LINE FAILURE" OFF "LOW BATTERY SHUTDOWN" ON	Battery voltage below low voltage cutout (after long outage). <i>or</i> Battery voltage below low voltage cutout (after several short outages).	Wait for line power to return and recharge batteries. Wait for batteries to recharge. *Check batteries and replace if necessary.
Batteries do not charge: "LOW BATTERY SHUTDOWN" ON	BATTERY breaker tripped. <i>or</i> Loose battery cable or connection. <i>or</i> Faulty batteries. <i>or</i> Open charger fuse.	Reset breaker. *Clean and tighten connections. *Check batteries and replace if necessary. *Check internal fuse on main circuit board and replace if necessary.

*** ITEMS TO BE PERFORMED ONLY BY A QUALIFIED TECHNICIAN**



NOTICE

This equipment generates, uses, and can radiate radio frequency energy if not installed and used in accordance with the instructions contained in the manual. It has been tested and found to comply with the limits established for a Class A computing device pursuant to Part 15 of FCC rules and the radio interference regulations of DOC which are designed to provide reasonable protection against such interference when this type of equipment is operated in a commercial environment. If the UPS appears to cause interference to radio or television reception, which can be determined by switching the unit OFF and ON, relocate the equipment and/or use an electrical circuit other than that used by the UPS.

6.7 Troubleshooting Using the SID

The OUTPUT LOAD LEDs, located on the front panel of the Standard Interface Device, are designed to display UPS fault conditions once the unit has detected an internal problem, indicated by the SERVICE LED. This information provided by the LEDs is extremely useful during troubleshooting and maintenance. If the UPS is equipped with an IID, refer to its operator's manual for further troubleshooting information.

If your UPS SERVICE LED is ON, press and hold the ALARM OFF switch for approximately 3 seconds. The OUTPUT LOAD LEDs indicate:

LED	STATUS	CONDITION
OVERLOAD OVERLOAD	Flashing ON	Not Applicable Fast Detector / Low Sensitivity Fault
100% 100%	Flashing ON	PLL Fault High Ambient Temperature
75% 75%	Flashing ON	Output Voltage High Output Voltage Short Circuit
50% 50%	Flashing ON	PWR BRD Fault / -5 VDC Failure PWR BRD EPROM Failure
25% 25%	Flashing ON	Self-Test Failure Battery Over-Voltage / Charger Fault

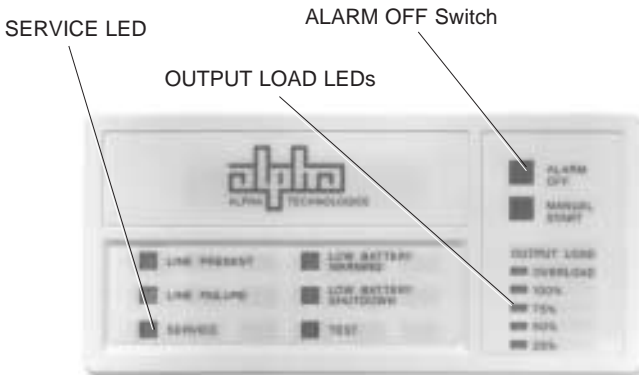

Standard Interface Device - Fault Indicators

**Fig. 40
Standard Interface Device (Troubleshooting)**

6. MAINTENANCE

6.7 Troubleshooting Using the SID, *continued*

SYMPTOM	CAUSE	REMEDY
OVERLOAD LED (ON) SERVICE LED (ON) ALARM OFF switch pressed and held:	Fast Detector / Low Sensitivity Fault.	Call Alpha.
100% LED (Flashing) SERVICE LED (ON) ALARM OFF switch pressed and held:	PLL Fault. Instability in line freq from generator; or out of phase wiring.	Wait for line power to return. Check wiring.
100% LED (ON) SERVICE LED (ON) ALARM OFF switch pressed and held:	High Ambient Temp. Caused by excessive load or heat source.	Reduce ambient temperature. Alarm will reset when temp returns to safe level.
75% LED (Flashing) SERVICE LED (ON) ALARM OFF Switch pressed and held:	Output Voltage High. Calibration problem or incorrect jumper setting on power board.	Contact Alpha.
75% LED (ON) SERVICE LED (ON) ALARM OFF Switch pressed and held:	Output Shorted <i>or</i> Output Voltage Low <i>or</i> Output Voltage Failure.	Check load Contact Alpha.
50% LED (Flashing) SERVICE LED (ON) ALARM OFF Switch pressed and held:	PWR BRD Fault or -5 VDC Failure.	Contact Alpha.
50% LED (ON) SERVICE LED (ON) ALARM OFF Switch pressed and held:	PWR BRD EPROM Failure.	Contact Alpha.
25% LED (Flashing) SERVICE LED (ON) ALARM OFF Switch pressed and held:	Self-Test Failure.	Check batteries and retest unit. Contact Alpha if unit continues to fail.
25% LED (ON) SERVICE LED (ON) ALARM OFF Switch pressed and held:	Battery Over-Voltage or Charger Fault.	Contact Alpha.

6.8 Repair Instructions

Before returning a unit to Alpha Technologies for repair, a Return Material Authorization (RMA) should first be obtained from Alpha's Customer Service Department. The RMA number should be clearly marked on the unit's original shipping container. If the original container is no longer available, the UPS should be packed with at least 3 inches of shock-absorbent material. **NOTE:** Do not use popcorn-type packing material. Returns should be prepaid and insured (COD and freight collect can not be accepted).

ALPHA TECHNOLOGIES DOES NOT ASSUME RESPONSIBILITY FOR DAMAGE CAUSED BY THE IMPROPER PACKAGING OF RETURNED UNITS.

6.9 Parts and Ordering Instructions

To order parts, contact the Alpha Technologies Customer Service Department directly at:

United States	(360) 647-2360
Canada	(604) 430-1476
United Kingdom	+44-1279-422110
Germany	+49-9122- 997303
Middle East	+357-5-375675

**TO OBTAIN COMPLETE TECHNICAL SUPPORT
(7 DAYS / WEEK, 24 HOURS / DAY)**

CALL

**1 - 8 0 0 - 3 2 2 - 5 7 4 2
(USA)**

**1 - 8 0 0 - 6 6 7 - 8 7 4 3
(Canada)**

7. SPECIFICATIONS

7.1 Specifications

	CFR 1500	CFR 2000	CFR 2500	CFR 3000
60 Hz Models				
Output Power (VA)	1500	2000	2500	3000
Active Power (WATTS)	1125	1340	1670	2000
Input Voltage (VAC)	120/208/240	120/208/240	120/208/240	120/208/240
Input Current Max. (A)	12.0/7.4/6.4	14.6/8.4/7.3	17.6/10.2/8.8	21/12/11
Output Voltage (VAC)	120/208/240	120/208/240	120/208/240	120/208/240
Battery Runtime* (Internal)	17	14	9	25
50 Hz Models				
Output Power (VA)	N/A	2000	2500	3000
Active Power (WATTS)	N/A	1340	1670	2000
Input Voltage (VAC)	N/A	230	230	230
Input Current Max. (A)	N/A	7.6	9.0	10
Output Voltage (VAC)	N/A	230	230	230

*Battery Run times are calculated at a typical load of 80%

NOTE: Specifications are at load and at temperature and based upon use with computer-type loads with a crest factor of 3:1 max., and a typical power factor of 0.75.

Dimensions

CFR 1500, 2000, 2500: 8.5"W x 21.3"H x 22.5"D
(216mm x 541mm x 571mm)
CFR 3000: 8.5"W x 21.3"H x 30"D
(216mm x 541mm x 762mm)

Weights

	60 Hz Models	50 Hz Models
CFR 1500	160 lbs./72 kg	N/A
CFR2000	171 lbs./78kg	174 lbs./79kg
CFR 2500	185 lbs./84kg	191 lbs./87kg
CFR3000	283 lbs./128 kg	289 lbs./131kg

Specifications subject to change without notice.

7.1 Specifications, *continued*

Common Specifications

Input Frequency	60 Hz or 50 Hz ($\pm 3\%$)
Input Voltage Variation	- 20% to + 10%
Output Frequency	± 0.1 Hz (inverter mode)
Output Regulation	$\pm 1\%$
Efficiency @Typical Load	90%
Total Harmonic Distortion	< 5%
Output Waveform	Sine
Step Load Response	< 10% @ 100% load
Noise Attenuation	
<i>Common Mode</i>	-120dB (100K - 1 MHz)
<i>Normal Mode</i>	-60dB (100K - 1 MHz)
Low Voltage Trigger	80% nominal voltage (adjustable)
High Voltage Trigger	110% nominal voltage (adjustable)
Batteries	Valve regulated, maintenance-free
Battery Voltage	48 VDC
Batt. Low Volt. Cutout	39 VDC (>25% load), [42 VDC (<25% load)]
Battery Recharge Time	5.0 hrs. for CFR 1500-2500 10 hrs. for CFR 3000
Charger	Linear (3A max.)
Charger Voltage	55.2 VDC at 25°C (adjustable)
Operating Temp	32°-104° F / 0° - 40°C
Heat Output	574 BTU/h; 168 W
Audible Noise @ 1M	42dBA
Indicators	Line Present, Line Failure, Low Battery Shutdown, Low Battery Warning (LED / audible alarm), Test, Service and Output Load
Controls	Manual Start / Test, Alarm OFF
Connectors	AC Input, AC Output, External Alarm; Intelligent Interface Device and External Battery
Output Alarms	Rear panel RJ-45 connector (Form C contact closures rated 1A, 30V) for Line Present / Line Failure, and Battery OK / Low Battery Warning

Specifications subject to change without notice.

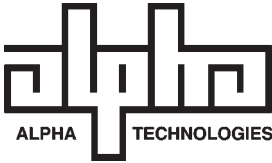

WARRANTY

Alpha Technologies warrants its equipment to be free of manufacturing defects in material and workmanship for a period of 24 months from the date of manufacture. The liability of Alpha Technologies under this warranty is solely limited to repairing, replacing, or issuing credit (at the discretion of Alpha Technologies) provided that:

1. Alpha Technologies is promptly notified in writing, or by telephone, that a failure or defect has occurred;

UNITED STATES

Alpha Technologies
3767 Alpha Way
Bellingham, WA 98226
Tel: (360) 647-2360
Fax: (360) 671-4936

CANADA

Alpha Technologies
5700 Sidley Street
Burnaby, B.C. V5J 5E5
Tel: (604) 430-1476
Fax: (604) 430-8908

UNITED KINGDOM

Alpha Technologies
Cartel Business Estate
Edinburgh Way
Harlow, Essex CM20 2DU
Tel: +44-1279-422110
Fax: +44-1279-423355

GERMANY

Alpha Technologies
Hansastrasse 8
D-91126 Schwabach
Tel: +49-9122-997303
Fax: +49-9122-997321

MIDDLE EAST

Alphatec
P.O. Box 6468
3307 Limassol, Cyprus
Tel: +357-5-375675
Fax: +357-5-359595

2. A Return Authorization number is obtained and clearly marked on the outside of the shipping container;
3. Customer is responsible for all shipping and handling charges (COD and freight collect will not be accepted without prior approval from Alpha Technologies);
4. The service engineer's examination of the returned unit shall disclose, to his satisfaction, that such defects have not been caused by misuse, neglect, improper installation, repair, alteration, or accident. If Alpha Technologies does determine that the unit has been damaged due to one of these causes, or if the unit is free of defects, a handling or repair fee will be necessary prior to returning the unit.

THIS 24 MONTH WARRANTY IS IN LIEU OF ALL OTHER WARRANTIES, EXPRESSED OR IMPLIED, INCLUDING, BUT NOT LIMITED TO, IMPLIED WARRANTIES OF MERCHANTABILITY AND FITNESS FOR A PARTICULAR PURPOSE.

IN NO CASE SHALL ALPHA TECHNOLOGIES BE LIABLE FOR ANY CONSEQUENTIAL DAMAGES FOR BREACH OF THIS OR ANY OTHER WARRANTY, EXPRESSED OR IMPLIED, WHATSOEVER.

ANY ACTION FOR BREACH OF THIS LIMITED 24 MONTH WARRANTY MUST BE BROUGHT WITHIN A PERIOD OF 24 MONTHS FROM DATE OF PURCHASE.

Alpha Technologies reserves the right to discontinue particular models and to make modifications in design and/or function at any time, without notice and without incurring obligations to modify previously purchased units.

EMERGENCY SHUTDOWN

IMPORTANT

THE UPS CONTAINS MORE THAN ONE LIVE CIRCUIT. DURING AN EMERGENCY, UTILITY POWER MAY BE DISCONNECTED AT THE SERVICE ENTRANCE OR MAIN ELECTRICAL PANEL TO PROTECT EMERGENCY PERSONNEL; HOWEVER, POWER WILL STILL BE PRESENT AT THE UPS OUTPUT.

TO PREVENT THE POSSIBILITY OF INJURY TO SERVICE OR EMERGENCY PERSONNEL, ALWAYS SWITCH THE UPS REAR PANEL BATTERY CIRCUIT BREAKER(S) OFF TO DE-ENERGIZE THE CIRCUIT.

EMERGENCY SHUTDOWN PROCEDURE:

1. Switch the rear panel BATTERY circuit breaker OFF.
2. Unplug the AC power cord from the wall receptacle or the back of the unit. If hardwired, switch the main panel AC breaker to the UPS OFF.

On units equipped with an Emergency Power Off option: Press the wall-mounted EPO switch (RED) to automatically deactivate the CFR's Battery Circuit.

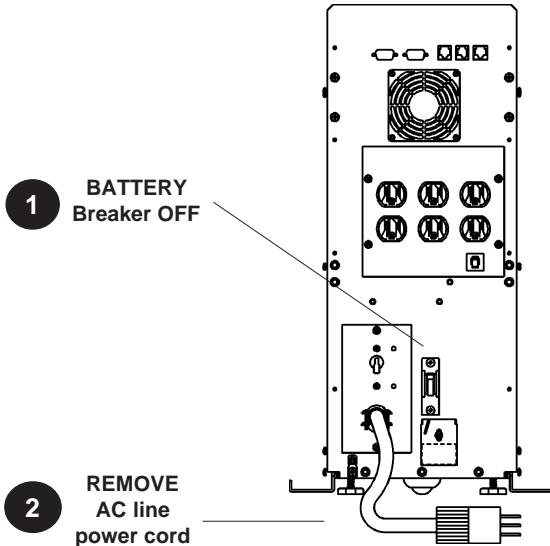

► **USA, LATIN AMERICA
& ASIA PACIFIC**

Alpha Technologies
3767 Alpha Way
Bellingham, WA 98226
Tel: (360) 647-2360
Fax: (360) 671-4936

► **CANADA**

Alpha Technologies
4084 McConnell Court
Burnaby, BC, V5A 3N7
Tel: (604) 430-1476
Fax: (604) 430-8908

► **UNITED KINGDOM,
EUROPE AND AFRICA**

Alpha Technologies
Cartel Business Estate
Edinburgh Way
Harlow, Essex CM20 2DU
Tel: +44-1279-422110
Fax: +44-1279-423355

► **GERMANY**

Alpha Technologies
Hansastrasse 8
D-91126 Schwabach
Tel: +49-9122-997303
Fax: +49-9122-997321

► **MIDDLE EAST**

Alphatec
P.O. Box 6468
3307 Limassol, Cyprus
Tel: +357-5-375675
Fax: +357-5-359595

► **AUSTRALIA**

Alpha Technologies
8 Anella Ave., Unit 6
Castle Hill, NSW 2154
Tel:+61(0)2 9894-7866
Fax:+61(0)2 9894-0234

<http://www.alpha.com>

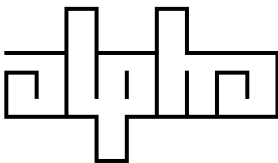

Power

Alpha sales and service offices located throughout the world

Printed in Canada

017-071-B0-002 4/96

© 1996 Alpha Technologies